6/2014

Technical Manual

MDT Glass push buttons

BE – GT0/GTT



4-fold/ 8-fold without Temperature sensor

4-fold/ 8-fold with Temperature sensor

1 Content

1 Content.....	2
2 Overview.....	4
2.1 Overview devices.....	4
2.2 Exemplary circuit diagram.....	5
2.2 Usage & Area of applications	6
2.4 Structure & Handling.....	6
2.5 Functions	7
2.5.1 Overview functions.....	8
2.6. Settings at the ETS-Software	9
2.7. Starting up	9
3 Communication objects.....	10
3.1 General	10
3.2 Communication objects per button	13
3.3 Default settings of the communication objects	16
4 Reference-ETS-Parameter	18
4.1 General	18
4.2 Configuration.....	20
4.3 Identical parameter	22
4.3.1 Blocking object	22
4.4 Parameter Channels grouped.....	22
4.4.1 Dimming	23
4.4.2 Shutter.....	25
4.4.3 Switch	26
4.5 Parameters channels unique.....	27
4.5.1 Switch	27
4.5.2 Scene	37
4.5.3 Switch short/long	39
4.5.4 One button dimming.....	42
4.5.5 One-button Shutter	43
4.6 Panic/Cleaning function	44
4.7 Configuration of LED lights.....	45
4.7.1 LED 1 – 4[8].....	47
4.7.2 LED Priority.....	49

4.8. Logik.....	50
4.8.1 Logic sub-function switch	52
4.8.2 Logikunterfunktion Szene und Wert	52
4.9 Room Temperature (BE-GTTxx.01).....	53
5 Index	55
5.1 Register of illustrations.....	55
5.2 List of tables.....	56
6 Attachment.....	57
6.1 Statutory requirements	57
6.2 Routine disposal	57
6.3 Assemblage.....	57
6.4 Datasheet	58

2 Overview

2.1 Overview devices

The manual refers to the following push buttons (Order Code respectively printed in bold type):

- **BE-GT04W.01** Glass push buttons 4-fold, white
 - surrounding orientation light, white/red LED per button
- **BE-GT04S.01** Glass push buttons 4-fold, black
 - surrounding orientation light, white/red LED per button
- **BE-GT08W.01** Glass push buttons 8-fold, white
 - surrounding orientation light, white/red LED per button
- **BE-GT08S.01** Glass push buttons 8-fold, black
 - surrounding orientation light, white/red LED per button
- **BE-GTT4W.01** Glass push buttons 4-fold, white, integrated temperature sensor
 - surrounding orientation light, white/red LED per button
- **BE-GTT4S.01** Glass push buttons 4-fold, black, integrated temperature sensor
 - surrounding orientation light, white/red LED per button
- **BE-GTT8W.01** Glass push buttons 8-fold, white, integrated temperature sensor
 - surrounding orientation light, white/red LED per button
- **BE-GTT8S.01** Glass push buttons 8-fold, black, integrated temperature sensor
 - surrounding orientation light, white/red LED per button

2.2 Exemplary circuit diagram

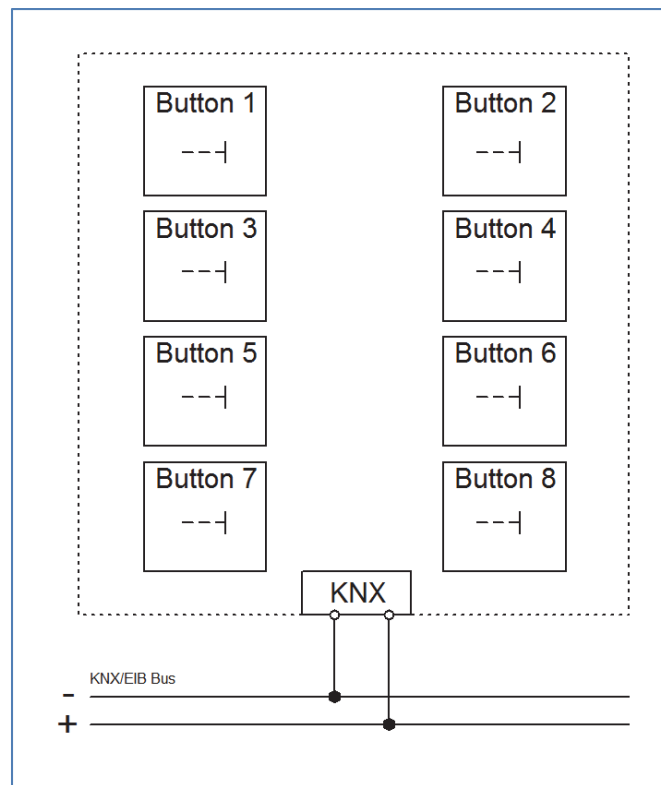

Figure 1: Exemplary circuit diagram BE-GT08.01-design with 8 buttons

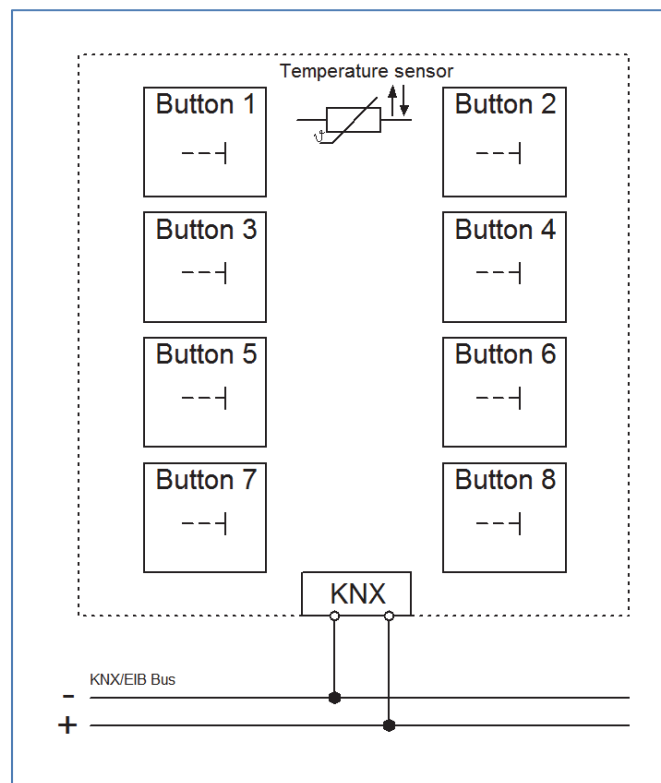

Figure 2: Exemplary circuit diagram BE-GTT8.01-Design with 8 buttons and temperature sensor

2.2 Usage & Area of applications

The push buttons contains of all functions of the binary input and are designed for flush mounting. By a simple push, the push button can call parameterized functions like scenes or dimming functions. All designs contain of a surrounding orientation light and an illuminated sensitive area, which can light white or red and adjusted with additional parameters. Four logics, a cleaning function and a “panic button” complete the service portfolio of the push button.

The push buttons of the series BE-GTT contain additional of an integrated temperature sensor, which can be used for the measurement of the room temperature.

2.4 Structure & Handling

The glass push buttons contain, according to the hardware design, of 4 or 8 buttons. Each contain of a free programmable background-LED. This can light as well red as white in 5 different illumination levels. Additional an orientation light can be activated. The glass surface is available in the colors black or white. Behind the surface, a marking draft can be inserted. A draft with a lot of symbols is available at http://www.mdt.de/EN_Downloads.html at the section “Other downloads”. All push buttons contains of bus connection at the back of the device as well as programming button at the side. An active programming mode is illustrated by the red programming LED. The push buttons of the series BE-GTTx.01 have the same style like the devices of the series BE-GT0x.01, but they contain of an additional temperature sensor.

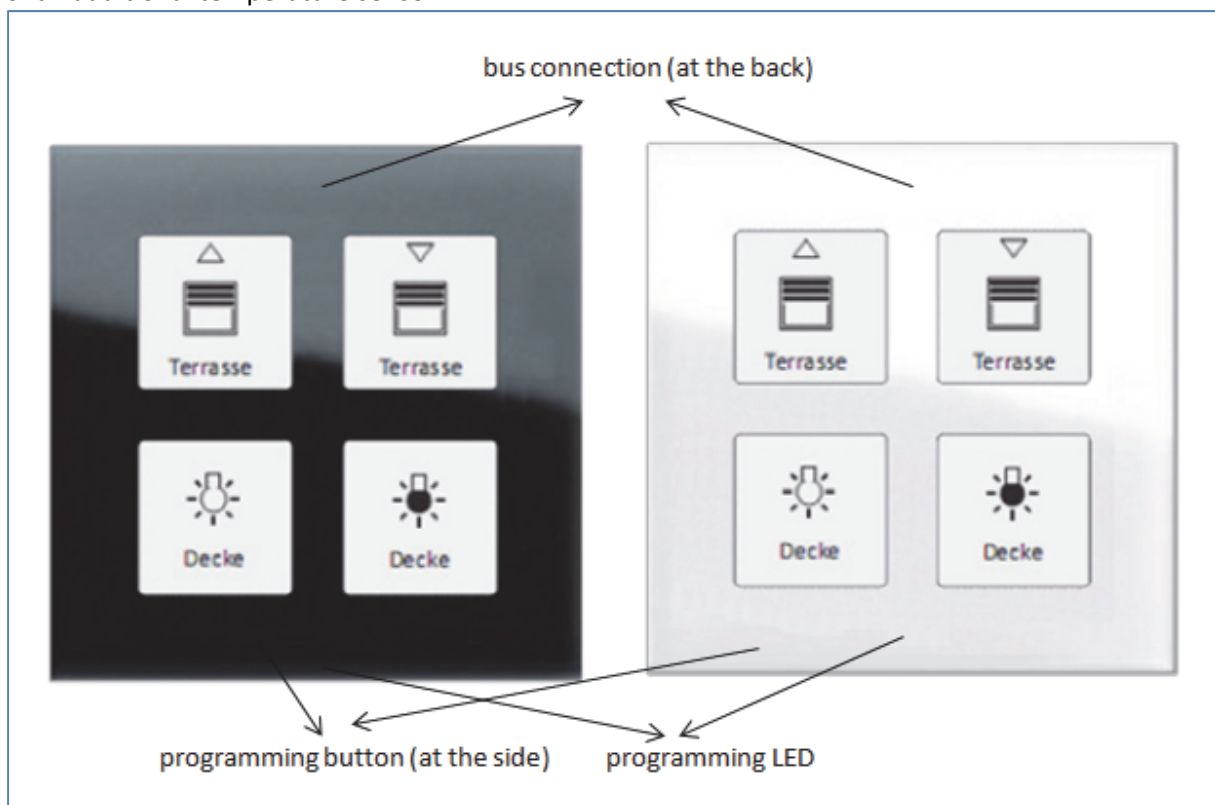

Figure 3: Overview hardware BE-GT04.01

2.5 Functions

The functions of the glass push buttons are divided into the general settings, the channel configuration, the settings for the panic button, the configuration of the LED display and the settings for the logic.

At the push buttons of the series BE-GTT, additional settings for the integrated temperature sensor are available.

The following menus can be shown and further parameterized there:

- **General settings**

The general settings are shown always. Changes, which are made here, are valid for the whole device. Settings for the reset behaviour and general settings can be made here.
- **Configuration of the buttons**
 - **disabled**

The channel is disabled and no communication objects are shown for this channel.
 - **Channels grouped**

If a channel is selected as “channel grouped”, the pair of channels can be parameterized as dimming function, switching function or shutter function.
 - **Channels unique**

If a channel is selected as “channel unique”, each channel can be parameterized as switch, scene, switch short/long, One-Button dimming or One-Button shutter.
- **Panic push button**

Here can be selected which function shall be called if more than 3 buttons are pressed. Different functions can be adjusted for the panic push button and the switchover between panic and cleaning can be selected.
- **Configuration LED lights**

For each button a background LED can be activated and adjusted. The background light can react as well to button activation as to an internal or external object.
- **Logic function**

Four adjustable logic blocks are available. For these an AND-Operation or an OR-Operation can be selected and the sending object can be parameterized as scene/value (1 Byte) or switch (1 Bit).
- **Room temperature (only at BE-GTT)**

The integrated temperature sensor can be used for sending the measured temperature to room temperature controller, as for example the SCN-RT6. So, no additional sensor is needed. Settings for the sending conditions of the temperature value and a communication object for an upper and lower threshold are available.

2.5.1 Overview functions

General settings	Resetverhalten	Behaviour at bus power reset
	Time for keystroke long	0,1-30s, selectable in steps
Channels grouped	Dimming function	brighter/darker function can be assigned to the channels freely
	Shutter function	up/down function can be assigned to the channels freely
	Switching function	off/on telegrams can be assigned to the channels freely
Channels unique	Switching function	<ul style="list-style-type: none"> • switching function • toggle function • status function • time functions <ul style="list-style-type: none"> ○ switch on/off delay • edge evaluation • forced settings • sending of byte-values
	Scene function	<ul style="list-style-type: none"> • memory function • selection of different scenes
	Switch short/long	<ul style="list-style-type: none"> • On-/Off-/toggle function • short/long independent parameterize able
	One button dimming	<ul style="list-style-type: none"> • dimming function with only one button
	One button shutter	<ul style="list-style-type: none"> • shutter function with only one button
Logic functions	AND –operation/OR - operation	<ul style="list-style-type: none"> • Switching function • Sending scenes/values • Inverting
Configuration of the LED lights	Status-LEDs	<ul style="list-style-type: none"> • Connection to internal objects available • Connection to external objects available • Reaction to button activation • LED display behaviour parameterize able • strength and colour adjustable • LED priority adjustabel
	Orientation light	<ul style="list-style-type: none"> • permanent ON/OFF • Controlling by external object
Panic/Cleaning function	Panic function	<ul style="list-style-type: none"> • different functions available
	Cleaning function	<ul style="list-style-type: none"> • Switchover cleaning/panic function adjustable
integrated temperature sensor	<ul style="list-style-type: none"> • Sending condition adjustable • Status object for maximum/minimum adjustable 	

Table 1: Overview functions

2.6. Settings at the ETS-Software

Selection at the product database:

Manufacturer: MDT Technologies

Product family: Push buttons

Product type:

Medium Type: Twisted Pair (TP)

Product name: addicted to the used type, e.g.: BE-GTT8.01 Push button 8-fold, integrated temperature sensor

Order number: addicted to the used type, e.g.: BE-GTT8.01

The available parameters depend to the chosen product type. The additional functions for the plus variant are not shown at the normal push buttons.

2.7. Starting up

After wiring the allocation of the physical address and the parameterization of every channel follow:

- (1) Connect the interface with the bus, e.g. MDT USB interface
- (2) set bus power up
- (3) Press the programming button at the device (red programming LED lights)
- (4) Loading of the physical address out of the ETS-Software by using the interface (red LED goes out, as well this process was completed successful)
- (5) Loading of the application, with requested parameterization
- (6) If the device is enabled you can test the requested functions (also possible by using the ETS-Software)

3 Communication objects

3.1 General

The following chart shows the general communication objects:

Nr.	Name	Object function	Data type	Direction	Info	Usage	Tip
20/40	Push button panic	Switch	DPT 1.001	sending	sends On or Off at activating the panic button	controlling actuator	Additional function for pressing all buttons
20/40	Push button panic	Send value	DPT 5.001	sending	sends adjusted value (0..255) at activation of the panic button	controlling actuator	Additional function for pressing all buttons
21/41	Push button panic	Value for toggle	DPT 1.001	receive	receives the last state (On/Off) of the controlled actuator	state object actuator, Visu	Additional function for pressing all buttons, for toggle function to get the last state and sending the opposed value
25/45	Logic input 1 A	Logic input 1 A	DPT 1.001	receive	logical input (receives on or off)	external switching, state objects of other devices	Additional function, up to 4 logical functions are available for the logical module, object appears only by activating „Logical object 1-4A (external)“
26/46	Logic input 1 B	Logic input 1 B	DPT 1.001	receive	logical input (receives On or Off)	external switching, state objects of other devices	Additional function, up to 4 logical functions are available for the logical module, object appears only by activating „Logical object 1-4B (external)“
27/47	Logic output 1	Logic output 1	DPT 1.001	sending	logical output; sends On or Off at activated logic	controlling actuator	Additional function, up to 4 logical functions are available for the logical module

Technical Manual Glass Push Buttons BE-GTXX.01

	Logic output 1 scene	Logic output 1 scene	DPT 18.001	sending	logical output; sends scene at active logic	controlling actuator	Additional function, up to 4 logical functions are available for the logical module
27/47	LED 1	Switch	DPT 1.001	receive	0 = LED On 1 = LED Off	external push button, external state objects/ Logical functions	For each button a LED can be activated, Object appears if „ LED 1 – 4[8] reacts at: external object“ is selected
37/57	LED priority 1	Switch	DPT 1.001	receive	calls parameterized functions for LED priority with 0 or 1	external button, external state objects/ Logical functions...	Additional function for LED-function, can be activated and parameterized for each LED
41/65	LED orientation light	Switch	DPT 1.001	receive	0 = Orientation light off 1 = Orientation light on	Day/Night object, external buttons, external state objects/logical function	Surrounding orientation light, can be activated once per push button, appears if Oreintation light “over ext. object” is activated
45/73	LED	Blocking object	DPT 1.003	receive	0 = enable LED-Function 1 = block LED-Funktion	Day/Night object, button, state object, logical function...	is shown when the LED blocking object is activated, can block, according to the settings, all LEDs or only some
46/74	Day/Night	Switch	DPT 1.002	receive	activates day/night mode with 0 or 1	button, clock timer, Visu	can be activated in the general LED-Settings, switches between day and night mode
47/75	Temperature	Measurement	DPT 9.001	sending	sends the current temperature in °C	Visu, Room temperature controller	sends the current temperature, if the room temperature sensor is activated (only at RF-GTTx.01)

Technical Manual Glass Push Buttons BE-GTXX.01

49/77	Temperature	State maximum value	DPT 1.001	sending	0 = maximum value not exceeded 1 = maximum value exceeded	Visu, alarm function...	sends a message if the maximum value is exceeded, can be activated in the menu "Room temperature" (only RF-GTTx.01)
50/78	Temperature	State minimum value	DPT 1.001	sending	0 = minimum value not undercut 1 = minimum value undercut	Visu, alarm function...	sends a message if the minimum value is undercut, can be activated in the menu "Room temperature" (only RF-GTTx.01)

Table 2: Communication objects general

3.2 Communication objects per button

The following chart shows the objects for each button:

Nr.	Name	Object function	Data type	Direction	Info	Usage	Tip
Configuration: Push buttons unique:							
0	Push Button 1	Switch	DPT 1.001	sending	sends On or Off at pushing/releasing the button	controlling actuator	can send the adjusted On or Off signal or both signals at toggling-function
0	Push Button 1	Send forced setting	DPT 2.001	sending	sends forced settings On/Off at pushing/releasing the button	controlling actuator/presence detector...	is shown if button is set as switch, and sub function send value is configured as forced setting (2 Bit)
0	Push Button 1	Shutter	DPT 1.008	sending	controlling shutter with short or long keystroke	controlling up/down movement of the shutter actuator	controlling the up/down movement of shutter/blinds Function: One button shutter
0	Push Button 1	Dimming On/Off	DPT 1.001	sending	Switching object of the dimming functions, sends On/Off	controlling of the switching function of dimming actuators	controlling the switching function of dimming actuators, responds on a short keystroke Function: One button dimming
0	Push Button 1	Send value	DPT 5.001	sending	sends adjusted value (0..255) at pushing/releasing button	sends an absolute value to an actuator	is shown if button is set as switch, and sub function send value is configured as 1 Byte value
1	Push Button 1	Value for toggle	DPT 1.001	receive	receives the last state(On/Off) of the controlled actuator	State object actuator, Visu	for toggle function to get the last state and sending the opposed value

Technical Manual Glass Push Buttons BE-GTXX.01

1	Push Button 1	Stop/Blinds open/close	DPT 1.009	sending	controlling slats via short or long keystroke, stops active up/down movement	controlling slat function of a shutter actuator	For controlling the step/stop function of shutter/blinds Function: One button shutter
1	Push Button 1	Dimming	DPT 3.007	sending	sends dimming value (0..255) to actuator	controlling actuator	Value is increased/decreased as long the button is pressed, direction depends to the last value respectively the value of object "Value for toggle" Function: One button dimming
2	Push Button 1	Value for change of direction	DPT 1.008	receive	receives last state (Up/Down) of the controlled shutter actuator	state object actuator, Visu	is used for the shutter function, for knowing the last value and sending the opposed value Function: One button shutter
2	Push Button 1	Scene	DPT 18.001	sending	sends adjusted scene number (1..64)	calling scenes in actuators	sends scene number at pressing the button Function: Scene
4	Push Button 1	Blocking object	DPT 1.003	receive	0 = enable button function 1 = block button function	state object actuator, other buttons, logical functions...	blocks the button, a blocked button cannot send any value available in all functions
+5 next button							
Configuration: Push buttons grouped:							
0	Push Buttons 1/2	Dimming On/Off	DPT 1.001	sending	Switching object of the dimming functions, sends On/Off	controlling actuator	controlling the switching function of dimming actuators, responds on a short keystroke Function: Dimming

Technical Manual Glass Push Buttons BE-GTXX.01

0	Push Buttons 1/2	Shutter down/up	DPT 1.008	sending	controlling shutter with short or long keystroke	controlling up/down movement of the shutter actuator	controlling the up/down movement of shutter/blinds Function: Shutter
0	Push Buttons 1/2	Switch on/off	DPT 1.001	sending	sends On/Off at pushing the button	Controlling actuator	can send the adjusted On or Off signal or both signals at toggling-function Function: Switch
1	Push Buttons 1/2	Dimming	DPT 3.007	sending	sends dimming value (0..255) to actuator	controlling actuator	Value is increased/decreased as long the button is pressed, direction depends to the last value respectively the value of object "Value for toggle" Function: Dimming
1	Push Buttons 1/2	Stop/Blinds open/close	DPT 1.009	sending	controlling slats via short or long keystroke, stops active up/down movement	controlling slat function of a shutter actuator	For controlling the step/stop function of shutter/blinds Function: Shutter
4	Push Buttons 1/2	Blocking object	DPT 1.003	receive	0 = enable button function 1 = block button function	state object actuator, other buttons, logical functions...	blockst he button, a blocked button cannot send any value available in all functions
+10 next grouped buttons							

Table 3: Communication objects per button

3.3 Default settings of the communication objects

Default settings									
Nr.	Button	Function	Length	Priority	C	R	W	T	U
0	Push Button 1	Switch	1 Bit	Low	X	X		X	
0	Push Button 1	Shutter	1 Bit	Low	X	X		X	
0	Push Button 1	Send value	1 Byte	Low	X	X		X	
0	Push Button 1	Dimming On/Off	1 Bit	Low	X	X		X	
0	Push Button 1	push-button short	1 Bit	Low	X	X		X	
0	Push Button 1	push-button short	1 Byte	Low	X	X		X	
0	Push Button 1	Send forced setting	2 Bit	Low	X	X		X	
0	Push Buttons 1/2	Dimming On/Off	1 Bit	Low	X	X		X	
0	Push Buttons 1/2	Shutter down/up	1 Bit	Low	X	X		X	
0	Push Buttons 1/2	Switch on/off	1 Bit	Low	X	X		X	
1	Push Button 1	Value for toggle	1 Bit	Low	X	X		X	
1	Push Button 1	Stop/Blinds open/close	1 Bit	Low	X	X		X	
1	Push Button 1	Dimming	4 Bit	Low	X	X		X	
1	Push Buttons 1/2	Dimming	4 Bit	Low	X	X		X	
1	Push Buttons 1/2	Stop/Blinds open/close	1 Bit	Low	X	X		X	
2	Push Button 1	Scene	1 Byte	Low	X	X		X	
2	Push Button 1	Value for toggle	1 Bit	Low	X		X	X	X
2	Push Button 1	Value for change of direction	1 Bit	Low	X		X	X	X
2	Push Button 1	Push-button long	1 Bit	Low	X	X		X	
2	Push Button 1	Push-button long	1 Byte	Low	X	X		X	
4	Push Button 1	Blocking object	1 Bit	Low	X		X		X
+ 5 next unique button, +10 next grouped pair of buttons									
20/40	Push button panic	Switch	1 Bit	Low	X	X		X	
20/40	Push button panic	Send value	1 Byte	Low	X	X		X	
21/41	Push button panic	Value for toggle	1 Bit	Low	X		X	X	X
24/44	Push button panic	Blocking object	1 Bit	Low	X		X		X
+ 3 next logic									
25/45	Logic input 1 A	Logic input 1 A	1 Bit	Low	X		X		X
26/46	Logic input 1 B	Logic input 1 B	1 Bit	Low	X		X		X
27/47	Logic output 1	Logic output 1	1 Bit	Low	X	X		X	
27/47	Logic output 1 scene	Logic output 1 scene	1 Byte	Low	X	X		X	

37/57	LED 1	Switch	1 Bit	Low	X		X	X	
+ 1 next LED									
41/65	LED priority 1	Switch	1 Bit	Low	X		X	X	
+ 1 next LED priority									
45/73	LED orientation light	Switch	1 Bit	Low	X		X	X	
46/74	LED	Blocking object	1 Bit	Low	X			X	
47/75	Day/Night	Switch	1 Bit	Low	X			X	
48/76	Temperature	Measurement	1 Byte	Low	X	X		X	
49/77	Temperature	State maximum value	1 Bit	Low	X	X			
50/78	Temperature	State minimum value	1 Bit	Low	X	X			

Table 4: Communication objects – Default settings

You can see the default values for the communication objects from the upper chart. According to requirements the priority of the particular communication objects as well as the flags can be adjusted by the user. The flags allocates the function of the objects in the programming thereby stands C for communication, R for Read, W for write, T for transmit and U for update.

4 Reference-ETS-Parameter

4.1 General

The following parameters are one-time available and affect to alle 4 or 8 channels:

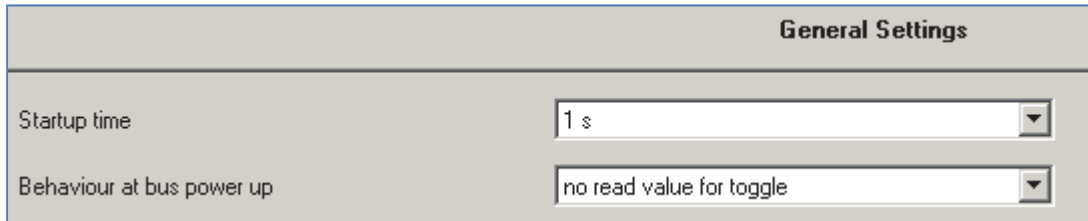

General Settings	
Startup time	1 s
Behaviour at bus power up	no read value for toggle

Figure 4: General settings

The chart shows the available settings for the general settings:

ETS-text	Dynamic range [default value]	comment
Limitation of telegrams	<ul style="list-style-type: none"> ▪ not active ▪ active 	activates/deactivates the limitation of telegrams
max quantity in 10 seconds	1-255 [15]	max number of telegrams per 10 seconds (appears only if the limitation of telegrams is activated)
Startup time	1s- 60s [1s]	Time between a download and the functional startup of the device
Behavior at bus power up	<ul style="list-style-type: none"> ▪ No read value for toggle ▪ Read value for toggle 	activates the reading of the value for toggle at bus power up

Table 5: General settings

- The limitation of telegrams can achieve that the bus gets not overloaded. An overloading of the bus-system can cause long waiting periods, e.g. at pushing a button. If the limitation of telegrams is activated and more telegrams than allowed are send, the telegrams above the limitation will be send at the next time interval. Therefore an overload of the bus can be prevented.
- The startup time defines the time which elapses after a download untill the device starts.
- The parameter “Behavior at bus power up” defines the behavior of the push button at a bus power return. The setting “Read value for toggle” effects that all communication objects “value for toggle” are read. So the push button knows the current status of the objects. If you choose the setting “no read value for toggle”, the push button will not know the current status of the actor. So the push button assumes an unconfirmed value for the objects “value for toggle” and sends always a “0”-signal at the next operation. Only now the push button knows the status of the actor and can send the right values. But if you choose the read of these values at a bus power up, the push button will send immediately the right value for toggling.

4.2 Configuration

The following illustration shows the available settings for each channel:

Push button setting

Function push buttons 1 / 2 (top left / right)	Push buttons grouped ▼
Function push buttons 3 / 4 (2. line left / right)	Push buttons unique ▼
Function push buttons 5 / 6 (3. line left / right)	disabled ▼
Function push buttons 7 / 8 (bottom left / right)	disabled ▼
Panic push button	
	not active ▼
Cleaning function	
	Cleaning = long button, Panic = short button ▼
Reaction rate	
	medium ▼
Time for keystroke long [s]	
	0,4 s ▼

Figure 5: Configuration of push buttons

The following chart shows the available settings:

ETS-text	Dynamic range [default value]	comment
Function push buttons 1/2 – [7/8]	<ul style="list-style-type: none"> ▪ disabled ▪ Push buttons grouped ▪ Push buttons unique 	Operating mode of the channels
Panic push button	<ul style="list-style-type: none"> ▪ active ▪ not active 	activates the panic function
Cleaning function	<ul style="list-style-type: none"> ▪ Cleaning = long button, Panic= short button ▪ Cleaning = short button, Panic= long button 	Setting which function shall be called at a long/short keystroke
Reaction rate	<ul style="list-style-type: none"> ▪ fast ▪ medium ▪ slow 	Adjustment of the reaction rate respectively debounce time of the push buttons
Time for keystroke long [s]	0,1s – 30s [0,4s]	defines the time when the ETS recognizes a long keystroke

Table 6: Channel configuration

- Three operating modes can be chosen at the submenu push button settings for each button. The further parameterization options depend on the chosen mode. If a channel is deactivated, so chosen as “disabled, there are no further parameterization options for this channel.
- By the activation of the panic buttons, an additional submenu is shown in which this function can be parameterized. Also the polarity if at a short or at a long keystroke the panic or the cleaning function shall be activated can be adjusted.
- The reaction rate is the debouncing time of the push buttons. This can be chosen as slow, medium or fast and defines how long a buttons must be pressed for calling the function. In order that at a call of the panic or cleaning function no unrequested function is called, this function should be adapted to the user.
- The parameter “Time for keystroke long” allocates a static value to the push button from which time a long keystroke is recognized. This parameter is important for functions, which have different functions for a long and a short keystroke.

4.3 Identical parameter

4.3.1 Blocking object

As well for grouped channels as for unique channels the blocking object can be activated. At the unique channels one blocking object for every channel can be activated. For grouped channels, you can activate one blocking object for both channels. The communication object for a channel appears as soon as it is activated for a channel. So there are up to 8 blocking objects parameterize able at a 8-fold push button. The corresponding channel of the blocking object is blocked by sending a logical 1. A blocked channel is not controllable as long as it is blocked. By sending a logical 0, the channel can be unblocked again.

Number	Name	Length	Usage
4	Blocking object	1 Bit	blocks the related channel by sending a logical 1

Table 7: Communication object blocking object

4.4 Parameter Channels grouped

The chart shows the setting options for grouped channels:

ETS-text	Dynamic range [default value]	comment
Button A/B	<ul style="list-style-type: none"> ▪ Dimming ▪ Shutter ▪ Switch 	Operating mode of the channel
Dimming function A/B	<ul style="list-style-type: none"> ▪ Brighter/Darker ▪ Darker/Brighter 	Defines which channel should dim up and which should dim down
Shutter function A/B	<ul style="list-style-type: none"> ▪ Up/Down ▪ Down/Up 	Defines which channel should drive the shutter a down and which up
Switch function A/B	<ul style="list-style-type: none"> ▪ On/Off ▪ Off/On 	Defines which channel should switch off and which on
Blocking Object	<ul style="list-style-type: none"> ▪ Inactive ▪ Active 	The blocking object can be displayed for every pair of channels

Table 8: Parameter Channels grouped

By choosing channels as grouped, two channels become one common function. The grouped function is called dual surface, like dual surface dimming, and dual surface shutter. In contrast to the single surface functions, one action can be performed independent form the other one. One input performs always one function. The assignment for the buttons can be made individually, so it is possible to configure which button should for example drive the shutters up and which down.

4.4.1 Dimming

The dual surface dimming function (channels grouped) is for controlling dimming actuators by start-stop dimming commands.

The following parameters are visible, when a pair of channels is chosen as dimming-function:



Figure 6: Parameter dual surface dimming

Number	Name	Length	Usage
0	Dimming on/off	1 Bit	Switching function of the dimming process; action for a short keystroke
1	Dimming	4 Bit	Dimming function; action for a long keystroke

Table 9: Communication objects dual surface dimming

When a pair of channels is parameterized as dimming function, two objects are shown. One object reacts to a short keystroke, the switching object “Dimming on/off”, and the other object reacts to a long keystroke, the dimming object “dimming”.

It is possible to parameterize this function as brighter/darker or as darker/brighter. The first function belongs always to the first button. If you switch this parameter, the function will be switched automatically.

By choosing the dimming function (channel A/B) as brighter/darker, the function reacts in this way: A short keystroke at button A switches the lights on. The lights are switched off by a short keystroke at button B. A long keystroke dims the lights step by step until releasing the long keystroke. The lights are dimmed brighter at button A and darker at button B. The push button starts always with the last brightness level, before switching off.

The step size is set fixed to 100% at the dual surface dimming. It is a start-stop dimming. that means the lights are dimmed as long as you hold the button. After releasing the button a stop value is sent, which stops the dimming process. So you can dim the lights with only one keystroke from 0% to 100% or from 100% to 0%, by pushing the button long enough.

The chart shows the correlations between the dimming- and the switching-object:

Button	Function Brighter/Darker		Function Darker/Brighter	
	Button A	Button B	Button A	Button B
Dimming function	Brighter	Darker	Darker	Brighter
Switching function	On	Off	Off	On

Table 10: Dimming function

The following diagram shows the dual surface dimming function:

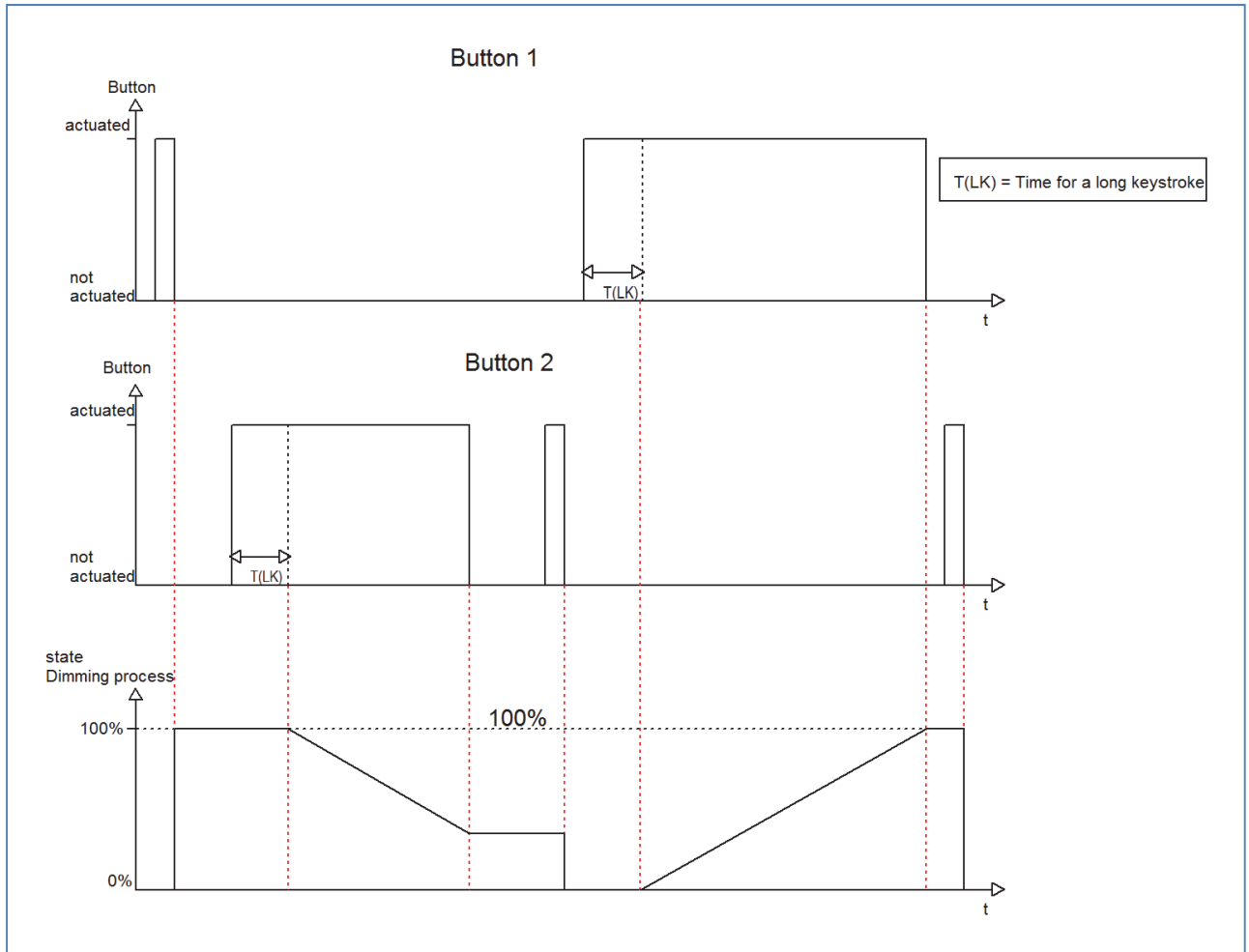

4.4.2 Shutter

The dual surface shutter-function triggers shutter actuators, which can drive shutter and blinds. The following parameters are shown, when a pair of channel is adjusted as shutter function:

Push buttons 1 / 2

Push buttons 1 / 2	Shutter ▼
Shutter function 1 / 2	Up, Down ▼
Operation function	Long=move / short=stop/Slats ▼
Blocking object	not active ▼

Figure 7: dual surface shutter function

Number	Name	Length	Usage
0	Shutter Down/Up	1 Bit	Driving function for the shutters, action for a long keystroke
1	Stop/Blinds Open/Close	1 Bit	Stop/Adjustment of the blinds, action for a short keystroke

Table 11: Communication objects dual surface shutter function

If you choose a pair of channels as shutter function, two communication objects will appear for this pair of channel. On the one hand the stop/blind adjustment object called “Stop/Blinds Open/Close”, which responds to a short keystroke and on the other hand the driving object called “Shutter Down/Up”, which responds to a long keystroke.

The driving object is for moving the shutters up and down. The stop-/blind adjustment object is for the adjustment of the blinds and additional it stops a running movement of the shutter.

Every shutter actuator controls with a 0-signal the up-movement and with a 1-signal the down movement. So the push button sends these signals to the corresponding driving commands. From hardware version 2.0 (have a look at the print of the side of the device: RX.X), it is additional possible to switch the functions for a long and a short keystroke. So it can be chosen whether he shutter/blinds shall be driven via a long or a short keystroke. The Stop-/Blind adjustment object is adjusted by the other operating concept.

The Chart shows the correlations between the Stop-/Blind adjustment object and the driving object for the individual channels:

	Function Down/Up		Function Up/Down	
	Button A	Button B	Button A	Button B
Stop-/Blind adjustment object	Down	Up	Up	Down
Driving object	Stop/close blinds	Stop/open blinds	Stop/open blinds	Stop/close blinds

Table 12: shutter function

4.4.3 Switch

The values for on and off can be assigned freely at the switching function for the grouped channels. If you adjust a pair of channel as switch, the following parameters will be shown:

Buttons 7 / 8

Buttons 7 / 8	<input style="width: 90%;" type="text" value="Switch"/>
Switch function 7 / 8	<input style="width: 90%;" type="text" value="on / off"/>
Blocking Object	<input style="width: 90%;" type="text" value="Inactive"/>

Figure 8: Two button switching function

Simple functions, like an alternating circuit, can be programmed easily by using the grouped switch function. The 1 bit communication object sends in dependence of the parameterization a 0- or a 1-signal for the first button and the inverted signal for the second channel. So you can chose which channel should switch off and which should switch on.

The following chart shows the corresponding communication object:

Number	Name	Length	Usage
0	Switch On/Off	1 Bit	Switching object for the dual surface switching function

Table 13: Communication object two button switching function

4.5 Parameters channels unique

There are 6 different operating modes for the unique channels, which can be adjusted for each channel:

- Inactive
- Switch
- Scene
- Switch short/long
- One button dimming
- One button shutter

After the assignment of the operating mode the further parameterization can be done. If the channel is selected as inactive, no further parameterization will be possible.

4.5.1 Switch

The switching function is for switching the corresponding output on, off and toggling it. There is a multitude of sub-functions at the switching function, which enables the user to evaluate edges and integrate times to the switching process.

The following parameters are shown, when the channel is selected as switch:

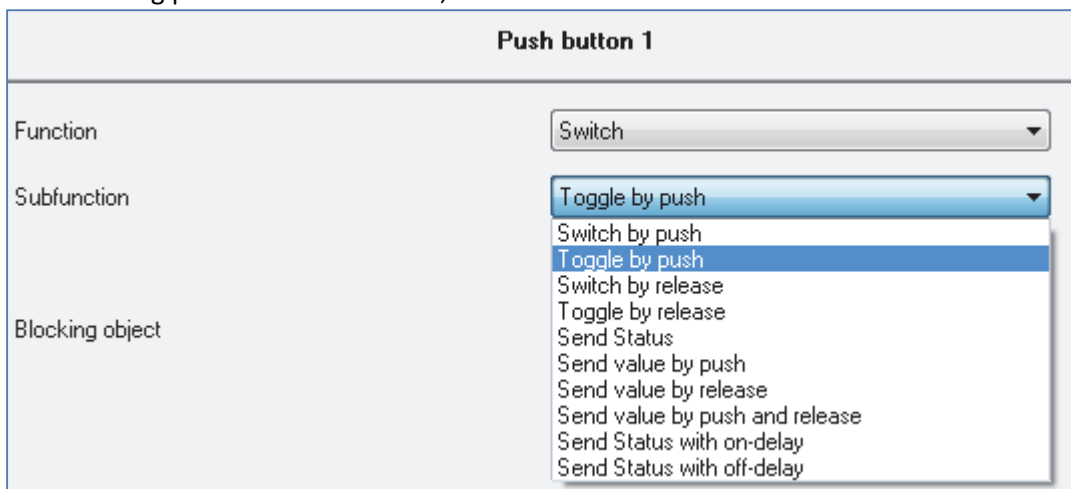

Push button 1	
Function	Switch
Subfunction	<ul style="list-style-type: none"> Toggle by push Switch by push Toggle by push Switch by release Toggle by release Send Status Send value by push Send value by release Send value by push and release Send Status with on-delay Send Status with off-delay
Blocking object	

Figure 9: Parameter switch

Various sub-functions are available at a switching output. Most of these sub-functions contain also of further parameterization-options. The different sub-functions as well as their parameterization-options are described in the following segments:

4.5.1.1 Switch by push/release

The following setting options are available, when the sub-function switch falling/rising edge was adjusted:

ETS-text	Dynamic range [default value]	comment
Value for release/push	<ul style="list-style-type: none"> ▪ On ▪ Off 	switches on/off at push/release

Table 14: Parameter switch by push/release

The sub-function “switch by push” or “switch by release” sends only a signal at the adjusted action. You can parameterize whether a 0-signal or a 1-signal should be sent. There is no inverted signal at subsiding the edge. This function always sends only one adjusted signal.

The following diagram shows this sub-function for switch by push. As soon as the state changes from 0 to 1, the push button sends an On-pulse (=1-signal):

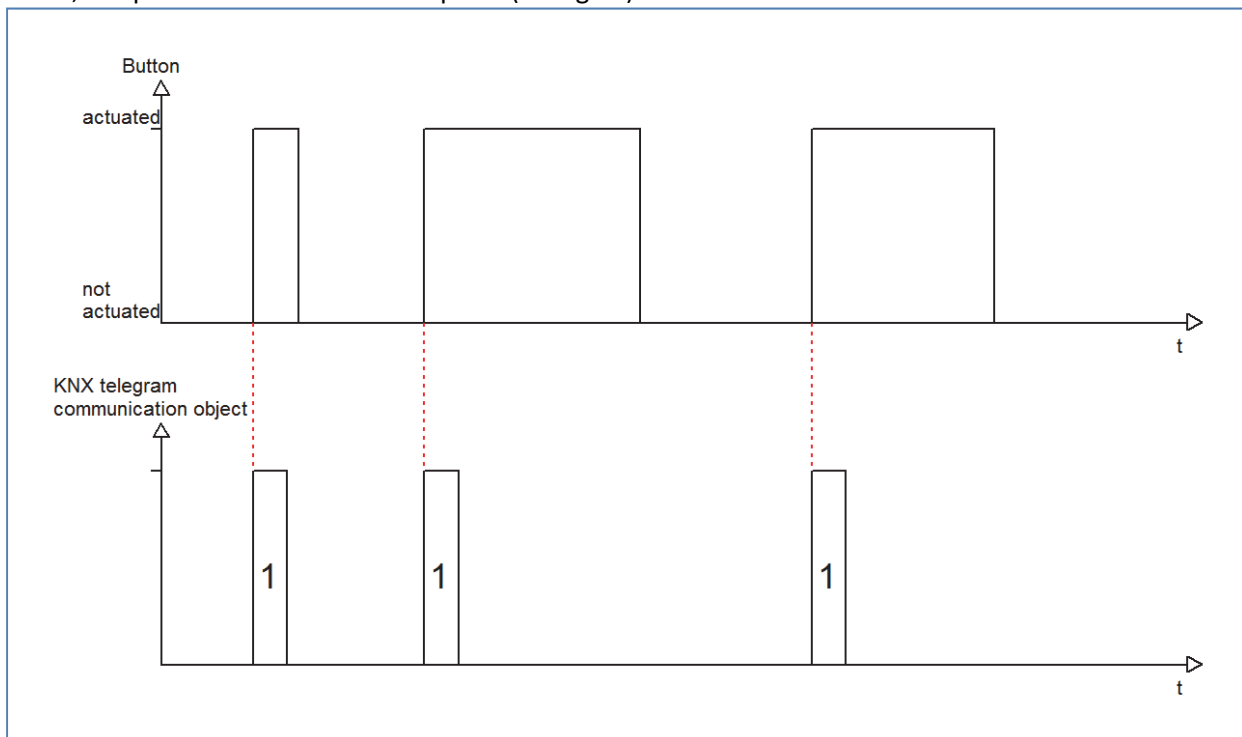

The following chart shows the corresponding communication object:

Number	Name	Length	Usage
0	Switch	1 Bit	Switching function, no differences between a long and a short keystroke

Table 15: Communication object switch by push/release

4.5.1.2 Toggle by push/release

The sub-function “toggle by push” or “toggle by release” toggles at the adjusted action. That means, the current value of the communication object is inverted at every switching process. By using this function an edge based alternating circuit can be realized.

The following diagram describes this sub-function. As soon as the state changes from 1 to 0, the push button sends the inverted signal. The signal is send always as a short pulse:

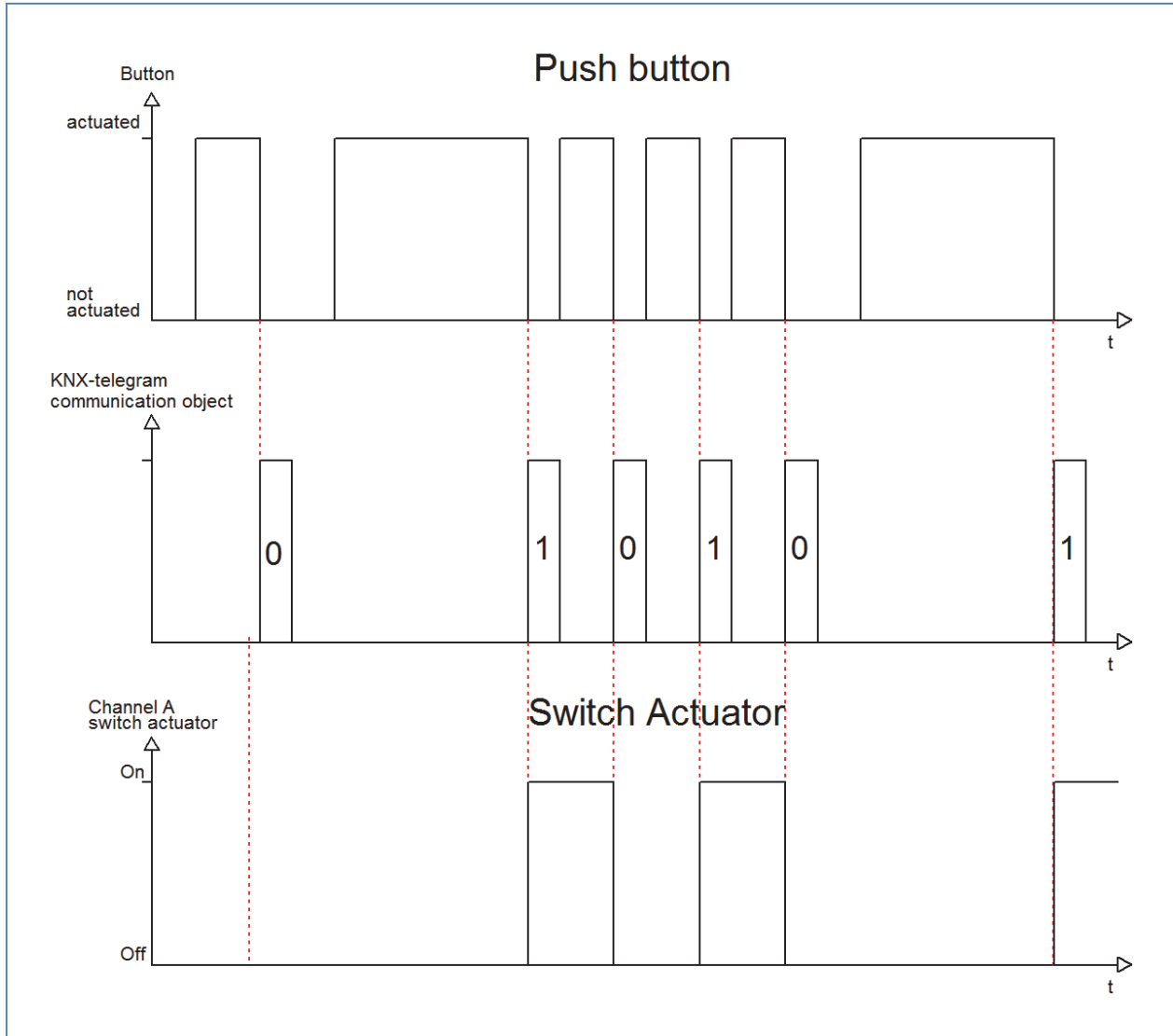

The following chart shows the corresponding communication objects:

Number	Name	Length	Usage
0	Switch	1 Bit	Switching function; no differences between long and short keystroke
1	Value for toggle	1 Bit	status object, indicates the switching state of the channel

Table 16: Communication objects toggle by push/release

To be sure that the push button toggles at every switching process, you have to connect the status object of the push button “Value for toggle” with the status object of the actuator. When the push button should work without an actuator, the object has to be connected to the switching object “switch”. The connection is important, because the push button cannot invert the signal, when it does not know its current state.

By undocking this communication object, you have more choices to program the push button. So you can use the object “Value for toggle” for visualizations or additional functions and you will be more free in design your project.

So you have for example the option to visualize the switching process by connecting the status-object to a switching object of a LED or something else.

4.5.1.3 Send Status

By using the sub-function „Send status“ the push button sends always the parameterized signal for the corresponding action. The following window is shown for the sub-function “Send status”:

Push button 1

Function	<input type="text" value="Switch"/>
Subfunction	<input type="text" value="Send Status"/>
Value for push	<input type="text" value="on"/>
Value for release	<input type="text" value="off"/>
Blocking object	<input type="text" value="not active"/>

Figure 10: Sub-function send status

These settings are available:

ETS-text	Dynamic range [default value]	comment
Value for push	<ul style="list-style-type: none"> ▪ On ▪ Off 	switches on/off by pushing
Value for release	<ul style="list-style-type: none"> ▪ On ▪ Off 	switches on/off by releasing

Table 17: Parameter Send status

The corresponding communication object is shown at the following chart:

Number	Name	Length	Usage
0	Switch	1 Bit	Switching function; no differences between long and short keystroke

Table 18: Communication object send status

The parameter “Value for push” defines whether the channel should send an 1-signal (value: On) or a 0-signal (value: Off). If you want for example switch a channel of a switch actuator, you will have to choose different values for push and release. Otherwise the push button sends the same signal twice, for example an On-signal.

The cyclic sending causes that the state of the push button is sent periodically in certain parameterizable intervals. Then the push button sends the parameterized value for the corresponding edge.

A common application for this parameter is for example the observation of windows, which are equipped with window-contacts. So a display can for example show whether all windows are closed or not. Furthermore an alarm device can operate with this function.

The following diagram describes this sub-function. In this example, the push button sends a 1-signal for release and a 0-signal for push. Additionally the diagram shows the connection with a switch actuator, which was parameterized with a normal switching function:

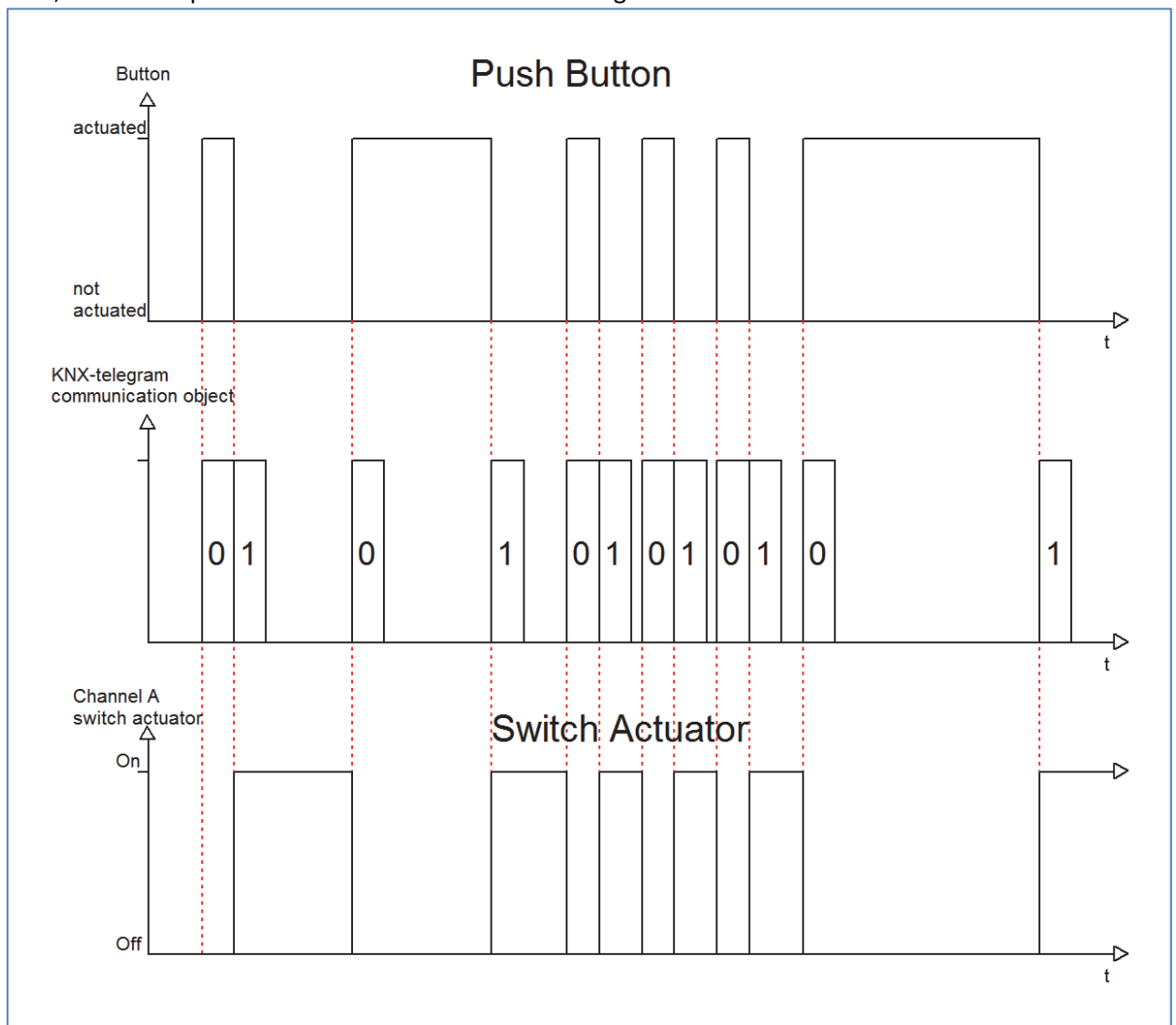

4.5.1.4 Send Value by push/release/push and release

There are two further sub-functions at the sub-function Send Value. On the one hand you can send 1 Byte Values and on the other hand you can activate a forced setting (2 Bit). These functions can be parameterized according to your wishes.

The following illustration shows this parameter:

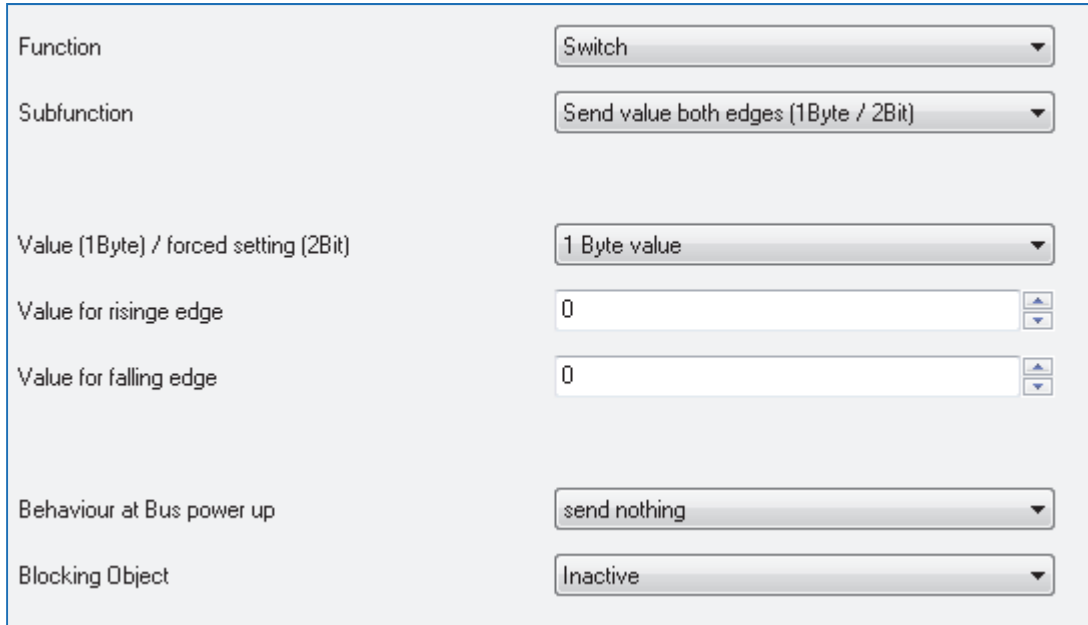

Figure 11: Sub-function send value

After activating the sub function „Send value“, you have to choose which values should be sent. The setting options are shown at the chart:

ETS-text	Dynamic range [default value]	comment
Value (1 Byte)/ forced setting(2 Bit)	<ul style="list-style-type: none"> ▪ 1 Byte Value ▪ 2 Bit Value(forced setting) 	Choice between 1 Byte- and 2 Bit-Value

Table 19: Parameter send value

If you have activated the setting “1 Byte”, the following settings are possible:

ETS-text	Dynamic range [default value]	comment
Value for psuh/release	0-255 [0]	Assignment, which value should be send for push/release

Table 20: Parameter send value, 1 Byte object

The 1 Byte communication object can send any value in its dynamic range at both edges. The dynamic range is thereby from 0-255. Depending on parameterization the push button sends the adjusted values for the rising or the falling edge or for both edges.

The following chart shows the according communication object:

Number	Name	Length	Usage
0	Send value	1 Byte	sends the parameterized value

Table 21: Communication object Parameter Send value-1 Byte object

The setting option 2 Bit value (forced setting) has the following options to parameterize this function:

ETS-text	Dynamic range [default value]	comment
Send forced setting at rising/falling edge	<ul style="list-style-type: none"> ▪ Forced setting not active ▪ Forced setting off ▪ Forced setting on 	Assignment, which forced setting should be send at which edge

Table 22: Dynamic range send value-forced setting

The forced setting object allows for example to control the automatic brightness control of presence detectors.

The forced setting object can send 3 different states:

- **Forced setting not active (control=0; value=0)**
The forced setting object has no influence on the receiver. For example at a presence detector, the automatic function (motion detector operation) would be switched on.
- **Forced setting off (control=1; value=0)**
The forced setting object switches the receiver unconditionally off. For example a presence detector, would be switched permanent off. Detected motions have no influence on the output.
- **Forced setting on (control=1, value=1)**
The forced setting object switches the receiver unconditionally on. For example a presence detector, would be switched permanent on. Detected motions have no influence on the output.

The according communication object is shown at the chart:

Number	Name	Length	Usage
0	Send forced setting	2 Bit	sends the adjusted forced setting

Table 23: Communication object Send value-forced setting

4.5.1.5 Send value with on/off delay

The following setting options are available at the function “Send value with on/off delay”:

ETS-text	Dynamic range [default value]	comment
Delay time	0-60min [1s]	Adjustment of the delay time for the sending process

Table 24: Parameter Send value with delay

The sub-function “Send value with on/off delay” allows that the push button sends its value after a parameterized time. At the on-delay, the time starts when the associated button was switched on and at the off-delay, the time starts when the associated button was switched off. The push button sends always its current value at this function. If the value changes before the time ran out, the on-delay will expire. For example, when an input with a parameterized on-delay is switched off, before it was switched on, the input remains off.

The following diagram describes the sub-function „Send value with on-delay“:

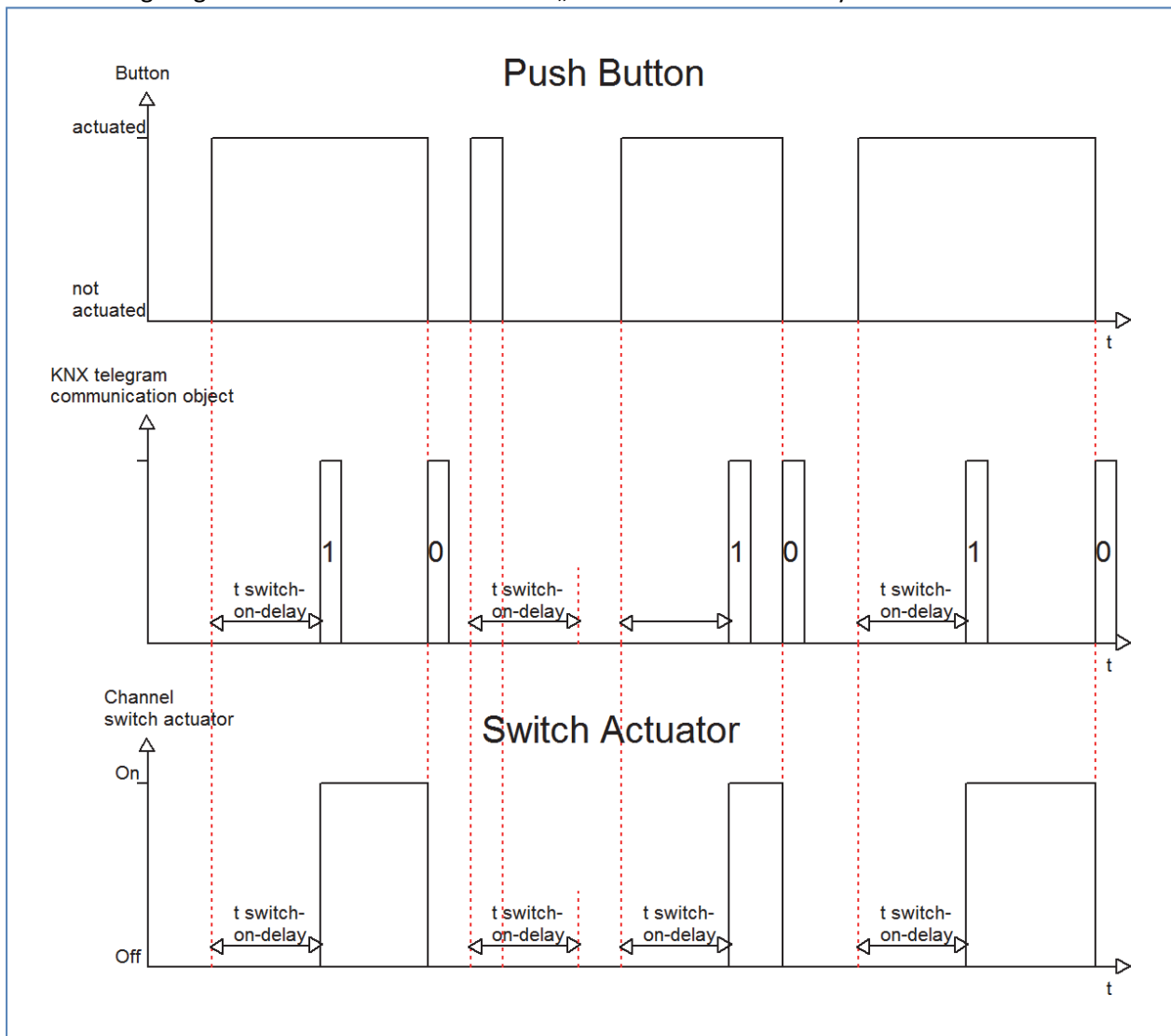

You can see the adjusted settings, which were made in the ETS for this setting:

Button 3

Function	Switch
Subfunction	Send Status with on-delay
Delay time	1 s
Blocking Object	<div style="border: 1px solid gray; padding: 5px;"> <ul style="list-style-type: none"> No Delay 1 s 2 s 3 s 5 s 10 s 15 s 30 s 45 s 60 s 2 min 3 min 5 min 10 min 15 min 30 min 45 min 60 min </div>

Figure 12: Communication object send value with delay

The following chart shows the communication object:

Number	Name	Length	Usage
0	Switch	1 Bit	Switching function; no differences between long and short keystroke

Table 25: Communication object send value with delay

4.5.2 Scene

The scene function calls scenes, which are saved in actuators. Scene numbers in the push button and the actuators must be identical. It is possible to save scenes by a long keystroke if the saving function was activated.

The following illustration shows the setting options for this parameter:

Button 4

Function	Scene ▼
Subfunction	Save ▼
Scene Number	1 ▼
Blocking Object	Inactive ▼

Figure 13: Parameter Scene

The following chart shows the dynamic range of this parameter:

Sub-function	Dynamic range [default value]	comment
Saving function	<ul style="list-style-type: none"> ▪ No save ▪ Save 	Saving function is selected by a long keystroke
Scene number	1-64 [1]	Scene number must be identical with the one in the actuators
Blocking object	<ul style="list-style-type: none"> ▪ Inactive ▪ Active 	have a look at 4.3.1 blocking object

Table 26: Sub-function scene

The chart shows the communication objects for this parameter:

Number	Name	Length	Usage
2	Scene	1 Byte	calls the depending scene

Table 27: Communication object Parameter scene

The scene function calls scenes, which were stored in actuators. Scenes contain of parameterized states of several actuators, which can be called with only one keystroke by using the scene function. Additional to the call of scenes, scenes can be saved at the call of a push button by a long keystroke. When the saving function was activated, a long keystroke at the push button saves the current state of the actuators to the depending scene.

For calling a scene or saving a new value for the scene, you have to send the accordingly code to the relevant communication object for the scene:

Scene	Retrieve		Save	
	Hex.	Dec.	Hex.	Dec.
1	0x00	0	0x80	128
2	0x01	1	0x81	129
3	0x02	2	0x82	130
4	0x03	3	0x83	131
5	0x04	4	0x84	132
6	0x05	5	0x85	133
7	0x06	6	0x86	134
8	0x07	7	0x87	135
9	0x08	8	0x88	136
10	0x09	9	0x89	137
11	0x0A	10	0x8A	138
12	0x0B	11	0x8B	139
13	0x0C	12	0x8C	140
14	0x0D	13	0x8D	141
15	0x0E	14	0x8E	142
16	0x0F	15	0x8F	143
17	0x10	16	0x90	144
18	0x11	17	0x91	145
19	0x12	18	0x92	146
20	0x13	19	0x93	147
21	0x14	20	0x94	148
22	0x15	21	0x95	149
23	0x16	22	0x96	150
24	0x17	23	0x97	151
25	0x18	24	0x98	152
26	0x19	25	0x99	153
27	0x1A	26	0x9A	154
28	0x1B	27	0x9B	155
29	0x1C	28	0x9C	156
30	0x1D	29	0x9D	157
31	0x1E	30	0x9E	158
32	0x1F	31	0x9F	159

Table 28: Calling and saving scenes

4.5.3 Switch short/long

The parameter switch short/long can assign the push button different switching processes for a long and a short keystroke.

The following illustration shows the sub-functions for this parameter:

Button 4

Function	<input type="text" value="Switch short/long"/>
Value for keystroke short - Object 1	<input type="text" value="On"/>
Value for keystroke long - Object 2	<input type="text" value="Nothing"/>
Blocking Object	<input type="text" value="Inactive"/>

Figure 14: Parameter switch short/long

The sub-functions for this parameter are shown in the chart below:

Sub-function	Dynamic range [default value]	comment
Value for keystroke short - Object 1	<ul style="list-style-type: none"> ▪ On ▪ Off ▪ Toggle ▪ Send value ▪ Nothing 	Action for a short keystroke
Value for keystroke long - Object 2	<ul style="list-style-type: none"> ▪ On ▪ Off ▪ Toggle ▪ Send value ▪ Nothing 	Action for a long keystroke
Blocking object	<ul style="list-style-type: none"> ▪ Inactive ▪ Active 	have a look at 4.3.1 blocking object

Table 29: Sub-functions parameter switch short/long

The chart shows the associated communication objects:

Number	Name	Length	Usage
0	push-button short	1 Bit/1 Byte	Switching function short keystroke
2	push-button long	1 Bit/ 1 Byte	Switching function long keystroke

Table 30: Communication object parameter switch short/long

The parameter “switch short/long” can control for example two channels of an actuator by using only one button. Furthermore you can switch a channel with a long keystroke on and with a short keystroke off. For both objects, a function can be set individually. Therefore the sub-functions on, off, toggle and nothing are available. Two communication objects are displayed, which can be connected in any way. By activating the sub-function “toggle” an additional communication object appears, called “value for toggling”. This object is a status object for the push button and must be connected to the status-object of the actuator (have a look at: 4.5.1 Toggle)

The following diagram shows the behavior of this parameter. Both objects (push-button and push-button long) were set to toggle. The object for the long keystroke is connected to channel A of the switch actuator and the object for the short keystroke is connected to channel B:

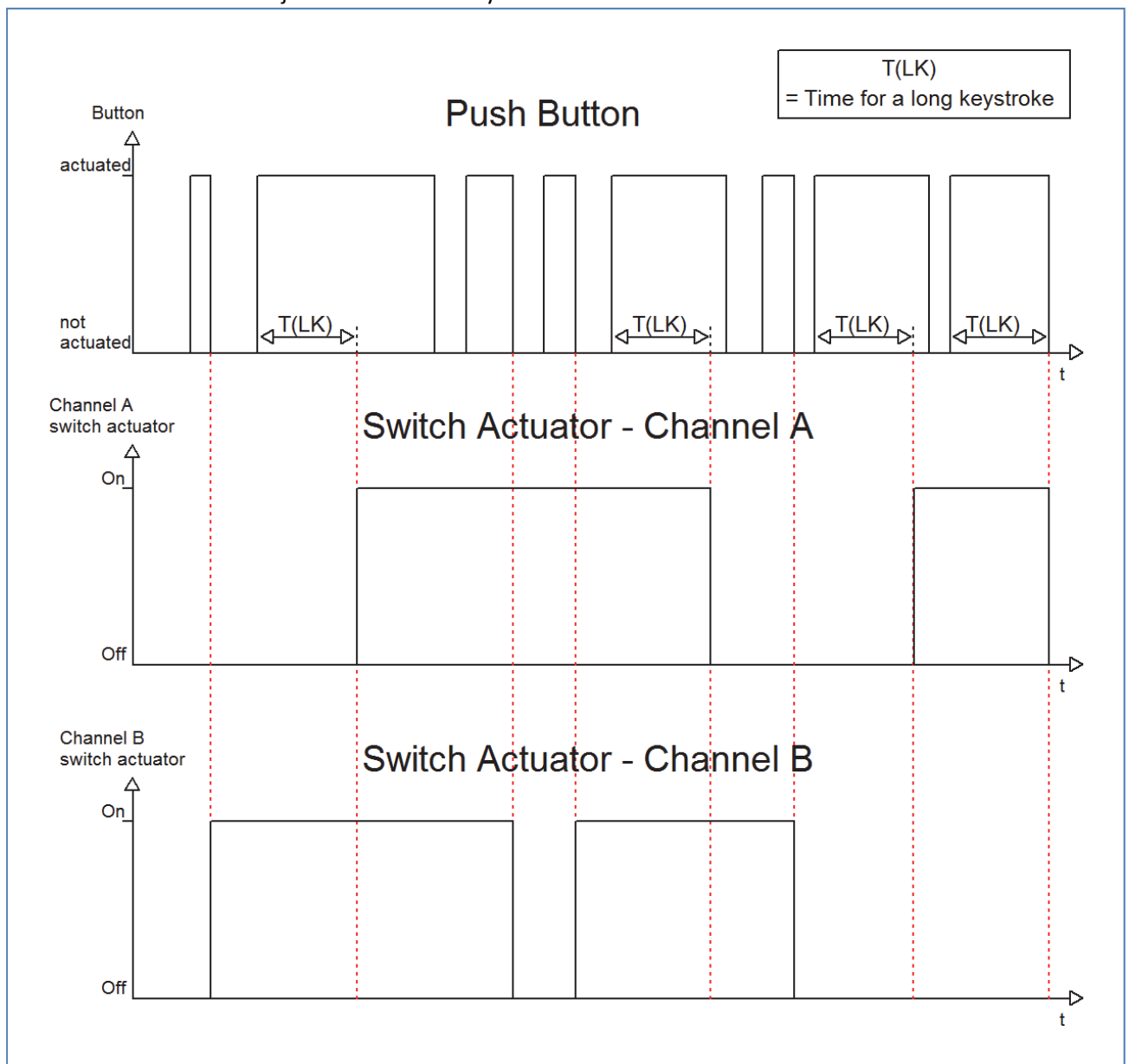

In this example the push button toggles Channel B with a short keystroke. The Channel A does not react to a short keystroke. This one reacts only at a long keystroke with toggling.

The following diagram shows a further application example for this parameter. In this example, the object for a long keystroke switches the channel A of a switch actuator on. A short keystroke switches the channel off. The three communication objects were connected in only one group address:

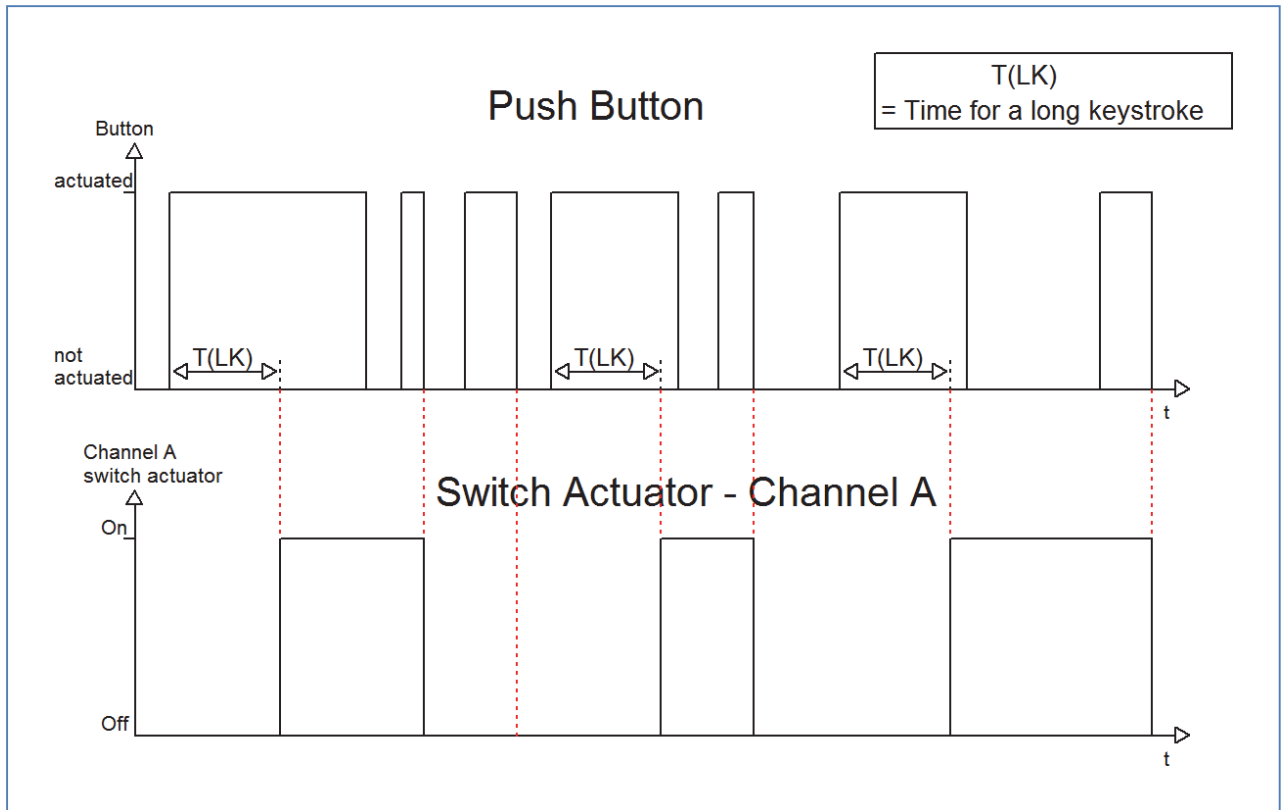

If the sub function "Send value" is selected, the following additional settings appear:

Sub-function	Dynamic range [default value]	comment
Value for keystroke short/long	Send value	chosen sub-function: Send value
Send value	<ul style="list-style-type: none"> ▪ 1 Byte-Value [0...255] ▪ Scene number 	Selection of the value, which shall be sent
1 Byte-Value [0...255]	0-255 [0]	Selection of the byte value, which shall be sent if byte value is chosen
Scene number	1-64 [1]	Selection of the scene number, which shall be sent if scene number is chosen

Table 31: Sub function Send value at switch short/long

Any value can be sent for the sub function „Send value“ at a short/long keystroke. As well scenes can be called as any byte value can be sent. So it is for example possible to call different scenes for a long and a short keystroke or sending absolute height/brightness commands.

4.5.4 One button dimming

At the dimming function for the single channels, the dimming process is proceeded by only one channel.

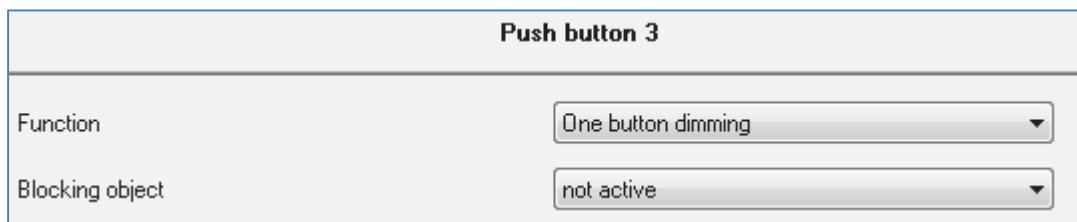

Figure 15: Parameter one-button dimming

At the following chart, the sub functions for this parameter are shown:

Sub-function	Dynamic range [default value]	comment
Blocking object	<ul style="list-style-type: none"> ▪ Inactive ▪ Active 	have a look at 4.3.1 blocking object

Table 32: Sub function one-button dimming

The chart shows the available communication objects:

Number	Name	Length	Usage
0	Dimming on/off	1 Bit	Switching function for the dimming process; action for the short keystroke
1	Dimming	4 Bit	dimming function; action for a long keystroke
2	Value for toggle	1 Bit	status object, must be connected with the status function of the actuator for getting feedback of the current switching process

Table 33: Communication objects one-button dimming

At the one-button dimming, the dimming process is executed by one single channel. So it is possible to dim the lights via only one button.

By a long keystroke the communication "Dimming" is called, which is responsible for the dimming process and by a short keystroke the object "Dimming on/off" is called which is responsible for the switching.

The dimming direction is toggled by every keystroke, so if you have dimmed darker, the next time will be dimmed brighter and vice versa.

The one-button dimming is a start stop dimming, that means when the dimming function is active a darker or brighter command is sent until the button is released again. After releasing the button a stop command is sent, which stops the dimming process. The dimming step is set fixed to 100%. So with only one button activation the lights can be dimmed from 0% to 100% or from 100% to 0%.

4.5.5 One-button Shutter

The shutter function for the unique channels, often called one-button shutter, performs the shutter-function by using only one channel.

Push button 3

Function	One button shutter ▼
Operation function	Long=move / short=stop/Slats ▼
Blocking object	not active ▼

Figure 16: Parameter one-button shutter

The sub-functions for this parameter are shown in the chart below:

Sub-function	Dynamic range [default value]	comment
Blocking object	<ul style="list-style-type: none"> ▪ Inactive ▪ Active 	have a look at 4.3.1 blocking object

Table 34: Sub-functions one-button shutter

The chart shows the communication objects for this parameter:

Number	Name	Length	Usage
0	Shutter	1 Bit	Driving function of the shutter, action for a long keystroke
1	Blinds/Stop	1 Bit	Stop/ Adjustment of blinds; action for a short keystroke
2	Value for change of direction	1 Bit	Shows the last driving command

Table 35: Communication objects one-button shutter

The one-surface dimming is performed by using only one channel. The communication object “Shutter” is addressed by a long keystroke and performs the up- and down-movement of the shutter. The direction of movement depends to the last direction of movement. If the shutter were driven up at the last time, they will be driven down at the next time. So the direction of movement changes after every movement.

The communication object “Blinds/Stop” is addressed by a short keystroke. Addressing this object stops a running movement of the shutter. Furthermore it will adjust the blinds if a shutter function is selected for this channel. The direction of the adjustment changes also here after every movement in the same way like the up/down moving of the shutter.

It is also possible to switch the functions for the short and the long keystroke. So it can be chosen whether a short or a long keystroke shall drive the shutter/blinds. The Stop-/ Adjustment object gets the other operating concept.

The object “Value for change of direction” serves as state object. It must be connected to the direction object of the actuator. So the button sends always the complementary value as before.

4.6 Panic/Cleaning function

If at least 3 buttons are pressed simultaneously, the panic or the cleaning function is activated. At the push button settings, have a look at 4.2 Configuration, can be defined which function shall be called at a short keystroke of at least 3 buttons and which function shall be called at long keystroke of at least 3 buttons.

The cleaning function is only a blocking of all buttons for the fixed adjusted time of 10 seconds. An active cleaning function is indicated by flashing of all white LEDs. The function allows an easy cleaning of the push button and avoids a function call during the cleaning process.

The panic function can generate an additional function call at the activation of at least 3 buttons. So function calls of central functions, like central on/off, forced settings can be generated or scenes can be called.

The following chart shows the menu for the panic buttons:

Panic push button

Subfunction Switch ▼

Value for push on ▼

Blocking object not active ▼

Figure 17: Parameter Panic push button

Folgende Parameter sind für die Paniktasten verfügbar:

Function	Dynamic range [default value]	comment
Sub-function	<ul style="list-style-type: none"> • Switch • Toggle • Send value 	Sub-function for the panic function
At Switch: Value for push	<ul style="list-style-type: none"> • On • Off 	At the sub function switch can be adjusted which value shall be sent
At send value: 1 Byte Value	0-255 [0]	If the sub function send value is adjusted as Byte value any value from 0-255 can be sent
At send value: 2 Bit Value (Forced setting)	<ul style="list-style-type: none"> • forced setting not active • forced setting ON • forced setting OFF 	If the sun function send value is adjusted as forced setting, the type of the forced setting can be adjusted
Blocking object	<ul style="list-style-type: none"> ▪ Inactive ▪ Active 	have a look at 4.3.1 blocking object

Table 36: Parameter Panic button

An activated panic function is indicated by a light up of all red LEDs for a half second. The light behaviour is adjusted fixed and can not be changed of the user. The panic function calls at the activation the adjusted settings.

If at the call of the panic the function also the functions for the single buttons are called, the reaction time should be adjusted slower. This setting can be done at the menu button configuration (have a look at 4.2 Configuration).

An active cleaning function is indicated by a flashing of all white LEDs at the rhythm 1:1 for the duration of the cleaning function. There are no further settings available for the cleaning function, because the cleaning function is only blocking of all buttons for the duration of 10 seconds.

4.7 Configuration of LED lights

The configuration of the LED lights is divided into the configuration, the general settings can be done at this menu, and the settings for each single LED per button.

The following illustration shows the menu Configuration of LED lights:

Configuration of LED lights	
Switching Day / Night	Day = 1 / Night = 0
LED orientation light	on
LED Orientation brightness by day	brightness 5
LED Orientation brightness by night	brightness 3
Block object for LED	not active
Behaviour of LEDs at bus power up	No read LED objects

Figure 18: Configuration of LED lights

The following parameters are for the LED-configuration available:

ETS-Text	Dynamic range [default value]	comment
Switching Day/Night	<ul style="list-style-type: none"> not active Day=1/Night=0 Day=0/Night=1 	Adjustment of the polarity of the day/night object
LED orientation light	<ul style="list-style-type: none"> Off On over ext. object 0=Off, 1=On over ext. object 1=Off, 0=On 	Activation and adjustment of the orientation light
LED orientation by day	<ul style="list-style-type: none"> Off Brightness 1 - 5 	Luminiscent behaviour of the orientation light at day
LED orientation by night	<ul style="list-style-type: none"> Off Brightness 1 - 5 	Luminiscent behaviour of the orientation light at night
Blocking object for LED	<ul style="list-style-type: none"> not active block button LEDs block orientation LED block all LEDs 	Activation of the blocking object and adjustment which LEDs shall be blocked
Behavior of LEDs at bus power up	<ul style="list-style-type: none"> Read LED objects No read all LED objects 	activates the read of the LED objects at bus power up

Table 37: Configuration LED lights

The parameters are explained at the following segments:

- Switching Day/Night**
 The day/night object is used for the brightness control of the LEDs. So it can be adjusted a brightness for every LED for daytime and for night. The polarity of the object can be adjusted.
- LED orientation**
 The orientation light can be switched permanent on or off. Further more it can be activated or deactivated by an external object.
- Blocking object for LED**
 A common blocking object for all LEDs exists. This can be activated at this parameter and the blocking behaviour can be defined. The blocking behaviour for each single LED can be realized via the priority setting.
- Behavior of LEDs at bus power up**
 If the LED objects are read at a bus power up, these know instantly its current state. If the objects are not read, all LEDs are called at a bus power up with the settings for switched off.

4.7.1 LED 1 – 4[8]

Every LED can be activated single and parameterized individually. This can be done at the submenu for each LED:

LED 1

LED 1 (top left) active	<input type="text" value="yes"/>
LED 1 reacts at:	<input type="text" value="external object and buttons activation"/>
LED characterization by day (value ON)	<input type="text" value="white brightness 3"/>
LED characterization by day (value OFF)	<input type="text" value="red brightness 3"/>
State of LED by day (value ON)	<input type="text" value="blinking"/>
LED characterization by night (value ON)	<input type="text" value="white brightness 3"/>
LED characterization by night (value OFF)	<input type="text" value="red brightness 3"/>
State of LED by night (value ON)	<input type="text" value="blinking"/>
Priority LED 1	<input type="text" value="not active"/>

Figure 19: Configuration LEDs per button

The following chart shows the available settings if the LED was activated:

ETS-Text	Dynamic range [default value]	comment
LED 1 – 4[8] reacts at	<ul style="list-style-type: none"> ▪ external object ▪ internal object ▪ button activation ▪ external object and button activation ▪ internal object and button activation 	Adjustment by what the LED shall be called
LED characterization by day (Value ON)	<ul style="list-style-type: none"> ▪ off ▪ white, brightness 1 – 5 ▪ red, brightness 1 – 5 ▪ [white, brightness 3] 	Luminiscent behaviour of the LED at day and value on
LED characterization by day (Value OFF)	<ul style="list-style-type: none"> ▪ off ▪ white, brightness 1 – 5 ▪ red, brightness 1 – 5 	Luminiscent behaviour of the LED at day and value off
State of LED by day (Value ON)	<ul style="list-style-type: none"> ▪ permanent ▪ blinking 	defines the luminescent behaviour when the LED is switched on

LED characterization by night (Value ON)	<ul style="list-style-type: none"> ▪ off ▪ white, brightness 1 – 5 ▪ red, brightness 1 – 5 ▪ [white, brightness 1] 	Luminiscent behaviour of the LED at night and value on
LED characterization by night (Value OFF)	<ul style="list-style-type: none"> ▪ off ▪ white, brightness 1 – 5 ▪ red, brightness 1 – 5 	Luminiscent behaviour of the LED at night and value off
State of LED by night (Value ON)	<ul style="list-style-type: none"> ▪ permanent ▪ blinking 	defines the luminescent behaviour when the LED is switched on

Table 38: Parameter LED 1-4[8]

The LED activated as follows:

- **external object**
By the activation via an external object, an additional communication object is shown, which can be called from every device at the bus system.
- **internal object**
By activation via an internal object, the LED can be called from any available object of the push button. For this purpose an additional window “Select of the object number” is shown in which the number of the calling object can be selected.
- **button activation**
The LED reacts standardly at the button activation. The value for on is called when the button is activated and the value for off when the button is not activated.
- **external object and button activation**
By this function it is possible to activate the LED via button activation and an external object. The settings for the LED characterization by value on and off refer to the external object. So the external object is preferential, because it has permanent a value. At the button activation, the LED lights 2 steps brighter. If the LED is already at the highest brightness level, the LED will be switched off at button activation. A blinking LED is switched into the permanent mode.
- **internal object und button activation**
By this function it is possible to activate the LED via button activation and an internal object. The settings for the LED characterization by value on and off refer to the internal object. So the internal object is preferential, because it has permanent a value. At the button activation, the LED lights 2 steps brighter. If the LED is already at the highest brightness level, the LED will be switched off at button activation. A blinking LED is switched into the permanent mode.

4.7.2 LED Priority

By using the LED priority fixed values can be generated and the LED can be locked for further activations.

The following illustration shows the LED priority:

Priority LED 1	activ if object LED priority value = 1
LED characterization by day	red brightness 4
State of LED by day (value ON)	permanent
LED characterization by night	red brightness 2
State of LED by night (value ON)	permanent

Figure 20: Parameter LED Priority

The following chart shows the available settings, when the LED priority was activated:

ETS-Text	Dynamic range [default value]	comment
Priority LED 1 – 4[8]	<ul style="list-style-type: none"> ▪ not active ▪ active, if object LED priority value = 1 ▪ active, if object LED priority value = 0 	Activation of the LED priority
LED characterization by day	<ul style="list-style-type: none"> ▪ off ▪ white, brightness 1 – 5 ▪ red, brightness 1 – 5 [white, brightness 3] 	Luminiscent behaviour of the LED at day when the priority is switched on
State of LED by day(value ON)	<ul style="list-style-type: none"> ▪ permanent ▪ blinking 	defines the luminescent behaviour when the LED is switched on
LED characterization by night	<ul style="list-style-type: none"> ▪ off ▪ white, brightness 1 – 5 ▪ red, brightness 1 – 5 [white, brightness 1] 	Luminiscent behaviour of the LED at night when the priority is switched on
State of LED by night(value ON)	<ul style="list-style-type: none"> ▪ permanent ▪ blinking 	defines the luminescent behaviour when the LED is switched on

Table 39: Parameter LED priority

The LED priority calls fixed adjusted brightness values for the corresponding LED and locks the LED for further activations. There is also at the LED priority a differentiation between day and night.

The following chart shows the communication objects for the LED lights:

Number	Name	Length	Usage
37/57	LED 1 – 4[8]	1 Bit	switches the LED on/off
41/65	LED priority 1 – 4[8]	1 Bit	switches the LED priority on/off
45/73	LED orientation	1 Bit	switches the orientation light on/off
46/74	LED Block object	1 Bit	activates the blocking function
47/75	Day/Night	1 Bit	Switchover between day and night

Table 40: Communication objects LED lights

4.8. Logik

The push buttons contain of 4 individually switchable and parameterize able logic blocks. At the following page, the logic blocks can be activated and the general settings can be made:

Settings for logic

Settings for logic 1	disabled ▼
Settings for logic 2	disabled ▼
Settings for logic 3	disabled ▼
Settings for logic 4	And ▼
Objecttype 4	Switch ▼
Sending condition	not automatic ▼
Output inverted	no ▼
Behaviour at bus power up	no read ext. logic objekts ▼

Figure 21: Activation logic functions

The following parameter can be adjusted once and is valid for all of the 4 logic blocks:

Sub-function	Dynamic range [default value]	comment
Behavior at bus power up	<ul style="list-style-type: none"> ▪ no read ext. logic objects ▪ read ext. logic objects 	sub-function indicates whether the external logic objects should be read or not at a bus power up

Table 41: Common Parameter logic blocks

If the read of the external logic at bus power up is activated, the status of all external logic objects will be read at a bus power up. So the logic operation is evaluated new. If this function is not active, the push button will hold the status before bus power outage.

The Chart shows the setting options for the logic blocks. The logic blocks can be assigned a logic function and an object type, the usage of this logic block:

Setting per logic [default value]	Dynamic range [default value]	comment
<ul style="list-style-type: none"> ▪ disabled ▪ And ▪ Or 	<ul style="list-style-type: none"> ▪ Switch ▪ Scene 	Every logic block can be adjusted as And- or as Or-function. Additional the object type (usage) can be adjusted for every block.

Table 42: Dynamic range logic

The following chart shows the communication objects for the logic functions:

Number	Name	Length	Usage
25/45	Logic input 1A	1 Bit	Communication object for an external logic; is only displayed when an external logic was activated
26/46	Logic input 1B	1 Bit	the same like logic input 1A
27/47	Logic Output 1	1 Bit	Output logic for switch is activated (=1-signal) when the logic block is true
27/47	Logic Output 1 Scene	1 Byte	Output logic for scenes is activated (=1-signal) when the logic block is true

Table 43: Communication objects logic

The communication objects for the other 3 possible logic blocks are the same like the first one. Three numbers are reserved for every logic block, so the next logic block starts at number 83.

As soon as a logic block is activated, a new sub-menu appears at the left selection list. In this menu can be set, which buttons should be connected to the logic block. Two external logic blocks can be activated additional. The external logic objects can be connected to communication objects of other devices by using the displayed communication objects "logic input 1 A&B".

Logic 4

Logical object 4 A (external)	disabled ▼
Logical object 4 B (external)	disabled ▼
Internal Input 1	Push button 2 ▼
Push button 2	normally active ▼
Internal Input 2	disabled ▼

Figure 22: Setting logic

The read of the inputs (number depends to the device type) can be activated for every channel and two external objects. They can be read normal or inverted.

4.8.1 Logic sub-function switch

The chart shows the possible sub-functions for the logic sub-function switch:

Sub-function	Dynamic range [default value]	comment
Sending condition	<ul style="list-style-type: none"> ▪ not automatic ▪ change of input ▪ change of output 	Adjustment indicates, when the state of the logic block should be sent
Output inverted	<ul style="list-style-type: none"> ▪ No ▪ Yes 	Adjustment indicates, whether the output should be inverted or not

Table 44: Logic sub-function switch

The sending condition adjusts, when the push button should send a signal on the bus. By adjusting the sending condition “change of input”, the push button sends a signal at every change of any input whether that causes a change of the logic operation or not. The setting “change of output” causes that the push button sends only a signal when the logic changes its current status.

The sub-function Output inverted indicates whether the output signal should be issued inverted (that means reversed 1->0 and 0->1) or normal.

The following diagram shows the logic operation switch as an and-function. The logic reads in this example the channels A and B as well as an external logic object. The Output is inverted:

4.8.2 Logikunterfunktion Szene und Wert

By using this logic sub-function scenes and byte values can be called.

The chart shows the available settings for the sub-function scene and value:

Sub-function	Dynamic range [default value]	comment
Scene number	1-64 [2]	Scene number must be the same like the one you want to call with the logic-function
1 Byte Value	0-255 [0]	Adjustment which byte value shall be sent when the logic function is true

Table 45: Logic sub-function scene and value

The logic function for the scenes and values works like a normal logic function. As soon as the logic function is satisfied, the communication object will send the adjusted scene-number or byte value. The communication object has the length of 1 Byte, so that it can be connected to other communication objects of scenes.

All sub-functions, like in a normal logic function can be parameterized. So you can set the logic function as an AND- or an OR-function and connect all inputs of the push button and additional 2 external logic objects to the logic function.

4.9 Room Temperature (BE-GTTxx.01)

The integrated room temperature sensor can send the room temperature to temperature controllers. So, no additional temperature sensors must be used.

The following chart shows the menu for the room temperature sensor:

Room temperature	
Sensor room temperature	active
Send temperature value cyclic	2 min
Alignment value (Value * 0,1 K)	0
Send temperature at changes of	0,3 °C
Upper state value	22 °C
Lower state value	7 °C

Figure 23: Room temperature sensor

The chart shows the available settings, when the room temperature was adjusted as active.

ETS-Text	Dynamic range [default value]	comment
Send temperature value cyclic	<ul style="list-style-type: none"> ▪ no send cyclic ▪ 1 min ▪ 2 min ▪ 3 min ▪ 5 min ▪ 10 min ▪ 15 min ▪ 20 min ▪ 30 min ▪ 60 min 	Adjustment if the temperature value shall be sent cyclic and defining of the time step
Alignment value (Value * 0,1K)	-50 – 50 [0]	The alignment value is for the increased/decrease of the measured value
Send temperature value at changes of	no send, 0,1°C – 5°C [0,3°C]	Adjustment if the temperature value shall be sent at a determined change
Upper state value	not active, 20°C – 40°C [22°C]	Determination of the upper reporting value
Lower state value	not active, 3°C – 30°C [7°C]	Determination of the lower reporting value

Table 46: Parameter room temperature sensor

The following settings are available:

- **Send temperature value cyclic**
 The temperature value can be sent in fixed time steps. The cyclic send is independent from a change of the temperature value.
- **Alignment value (Value * 0,1K)**
 The measured temperature value can be corrected by this setting. By choosing a negative value for this parameter, the measured value will be lowered and by choosing a positive value, the measured value will be lifted. The value is multiplied by 0,1K, so the current value can be lowered or lifted up to 5K. This setting is useful, when the sensor was built at an unfavorable location, e.g. becoming draft or next to a window. When this function is activated, the temperature controller will also send the corrected values.
 All sensors are matched in-plant to 0,1K.
- **Send temperature at change of**
 By using this setting, the temperature can be sent at a determined absolute change.
- **Lower/upper state value**
 If an upper/lower state value is adjusted, two additional 1Bit objects are shown. These send a 1-signal, when the temperature exceeds the upper state value or falls below the lower state value.

The following communication objects are available for the room temperature sensor:

Number	Name	Length	Usage
48	Measurement	2 Byte	sends the current temperature value
49	State maximum value	1 Bit	sends a 1-signal, when the temperature exceeds the adjusted value
50	State minimum value	1 Bit	sends a 1-signal, when the temperature falls below the adjusted value

Table 47: Communication objects room temperature sensor

5 Index

5.1 Register of illustrations

Figure 1: Exemplary circuit diagram BE-GT08.01-design with 8 buttons.....	5
Figure 2: Exemplary circuit diagram BE-GTT8.01-Design with 8 buttons and temperature sensor	5
Figure 3: Overview hardware BE-GT04.01	6
Figure 4: General settings.....	18
Figure 5: Configuration of push buttons	20
Figure 6: Parameter dual surface dimming.....	23
Figure 7: dual surface shutter function	25
Figure 8: Two button switching function	26
Figure 9: Parameter switch	27
Figure 10: Sub-function send status.....	31
Figure 11: Sub-function send value	33
Figure 12: Communication object send value with delay	36
Figure 13: Parameter Scene	37
Figure 14: Parameter switch short/long	39
Figure 15: Parameter one-button dimming	42
Figure 16: Parameter one-button shutter.....	43
Figure 17: Parameter Panic push button	44
Figure 18: Configuration of LED lights	45
Figure 19: Configuration LEDs per button.....	47
Figure 20: Parameter LED Priority	49
Figure 21: Activation logic functions	50
Figure 22: Setting logic	51
Figure 23: Room temperature sensor	53

5.2 List of tables

Table 1: Overview functions.....	8
Table 2: Communication objects general.....	12
Table 3: Communication objects per button	15
Table 4: Communication objects – Default settings.....	17
Table 5: General settings.....	18
Table 6: Channel configuration	20
Table 7: Communication object blocking object	22
Table 8: Parameter Channels grouped.....	22
Table 9: Communication objects dual surface dimming	23
Table 10: Dimming function	24
Table 11: Communication objects dual surface shutter function	25
Table 12: shutter function	25
Table 13: Communication object two button switching function	26
Table 14: Parameter switch by push/release.....	28
Table 15: Communication object switch by push/release	28
Table 16: Communication objects toggle by push/release	29
Table 17: Parameter Send status	31
Table 18: Communication object send status	31
Table 19: Parameter send value.....	33
Table 20: Parameter send value, 1 Byte object.....	33
Table 21: Communication object Parameter Send value-1 Byte object	33
Table 22: Dynamic range send value-forced setting	34
Table 23: Communication object Send value-forced setting	34
Table 24: Parameter Send value with delay.....	35
Table 25: Communication object send value with delay	36
Table 26: Sub-function scene	37
Table 27: Communication object Parameter scene	37
Table 28: Calling and saving scenes.....	38
Table 29: Sub-functions parameter switch short/long	39
Table 30: Communication object parameter switch short/long	39
Table 31: Sub function Send value at switch short/long.....	41
Table 32: Sub function one-button dimming	42
Table 33: Communication objects one-button dimming	42
Table 34: Sub-functions one-button shutter.....	43
Table 35: Communication objects one-button shutter	43
Table 36: Parameter Panic button	44
Table 37: Configuration LED lights	46
Table 38: Parameter LED 1-4[8]	48
Table 39: Parameter LED priority	49
Table 40: Communication objects LED lights	50
Table 41: Common Parameter logic blocks.....	50
Table 42: Dynamic range logic	51
Table 43: Communication objects logic	51
Table 44: Logic sub-function switch	52
Table 45: Logic sub-function scene and value.....	52
Table 46: Parameter room temperature sensor	53
Table 47: Communication objects room temperature sensor	54

6 Attachment

6.1 Statutory requirements

The above-described devices must not be used with devices, which serve directly or indirectly the purpose of human, health- or lifesaving. Further the devices must not be used if their usage can occur danger for humans, animals or material assets.

Do not let the packaging lying around careless, plastic foil/ -bags etc. can be a dangerous toy for kids.

6.2 Routine disposal

Do not throw the waste equipment in the household rubbish. The device contains electrical devices, which must be disposed as electronic scrap. The casing contains of recyclable synthetic material.

6.3 Assemblage



Risk for life of electrical power!

All activities on the device should only be done by an electrical specialist. The county specific regulations and the applicable EIB-directives have to be observed.

MDT Glass Push Button 2/4/6/8-fold Plus, flush mounted

Version		
BE-GT04W.01	Glass Push Button 4-fold Plus	Flush mounted, White
BE-GT04S.01	Glass Push Button 4-fold Plus	Flush mounted, Black
BE-GT08W.01	Glass Push Button 8-fold Plus	Flush mounted, White
BE-GT08S.01	Glass Push Button 8-fold Plus	Flush mounted, Black
BE-GTT4W.01	Glass Push Button 4-fold Plus	Flush mounted, White, integrated Temperature Sensor
BE-GTT4S.01	Glass Push Button 4-fold Plus	Flush mounted, Black, integrated Temperature Sensor
BE-GTT8W.01	Glass Push Button 8-fold Plus	Flush mounted, White, integrated Temperature Sensor
BE-GTT8S.01	Glass Push Button 8-fold Plus	Flush mounted, Black, integrated Temperature Sensor

The MDT Glass Push Button releases KNX telegrams after touching the sensor areas on top, 1 or 2 Button operation can be parameterized. The device provides extensive functions like switching of lighting, operation of blinds and shutters, contact type and block communication objects for each channel. The Glass Push Button has 4 integrated logical modules. The sending of a second object is possible by the logical modules.

Furthermore the MDT Glass Push Button has an integrated cleaning function and an additional switching channel that operates if 3 or more of the sensor area were touched (e.g. panic function).

For individually marking of the MDT Glass Push Button you can insert a labeling film behind the glass front. The labeling film for laser printers is included in delivery. You find the marking draft in our download area.

The MDT Glass Push Button has a surrounding orientation light LED and a bicolored (White/Red) LED for sensor area. These LED can be set from internal or external objects, the brightness of the LED is adjustable in 5 steps (Day and night can be set independent). The LED can display 3 situations like: LED off 0 „absent“, LED white „present“, LED red „window open“.

The MDT Glass Push Button is a flush mounted device (BE-GTx4x.01: 1 outlet socket, BE-GTx8x.01: 2 outlet sockets with center-to-center gauge 71mm) for fixed installations in dry rooms, it is delivered with support ring.

For project design and commissioning of the MDT KNX Glass Push Button it is recommended to use the ETS3f/ETS4 or later. Please download the application software at www.mdt.de/downloads.html

BE-GT04W.01

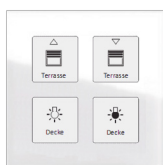

BE-GT04S.01



BE-GT08W.01



BE-GT08S.01

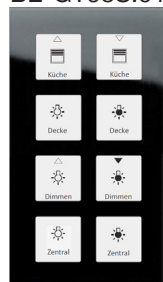

- Production in Germany, certified according to ISO 9001
- Sensor areas can be parameterized for 1 or 2 button operation
- NO or NC contact operation, programmable length of button push
- Forced setting function for each output
- Operation with short/long button push and 2 objects
- White/Red LED for each sensor area
- 4 integrated logical modules
- Cleaning function
- Additional switching channel (e.g. panic function)
- **Surrounding orientation light with day/night object**
- **Integrated Temperature Sensor (BE-GTTxx.01 only)**
- Brightness of LED adjustable in 5 steps via day/night object
- Sending of a second object is possible by the logical modules
- Operation of blinds and shutters, 1 and 2 button operation
- **Title block to insert behind glass front, labeling film included**
- Installation with support ring (included in delivery)
- Integrated bus coupling unit
- 3 years warranty

Technical Data	BE-GT04W.01 BE-GT04S.01	BE-GT08W.01 BE-GT08S.01	BE-GTT4W.01 BE-GTT4S.01	BE-GTT8W.01 BE-GTT8S.01
Number of sensor areas	4	8	4	8
Number of bicolored LED	4	8	4	8
Orientation LED	Surrounding	Surrounding	Surrounding	Surrounding
Measurement range temperature	--	--	0 to + 40°C	0 to + 40°C
Permitted wire gauge				
KNX busconnection terminal	0,8mm Ø, solid core	0,8mm Ø, solid core	0,8mm Ø, solid core	0,8mm Ø, solid core
Power supply	KNX bus	KNX bus	KNX bus	KNX bus
Power consumption KNX bus typ.	< 0,3W	< 0,3W	< 0,3W	< 0,3W
Operation temperature range	0 to + 45°C	0 to + 45°C	0 to + 45°C	0 to + 45°C
Enclosure	IP 20	IP 20	IP 20	IP 20
Dimensions (W x H x D)	92mm x 92mm x 28mm	92mm x 163mm x 28mm	92mm x 92mm x 28mm	92mm x 163mm x 28mm
Required outlet sockets for installation	1	2*	1	2*

* The center-to-center gauge of the outlet sockets has to be 71mm. Bus connection terminal is in lower socket.

Exemplary circuit diagram BE-GTxxx.01

