

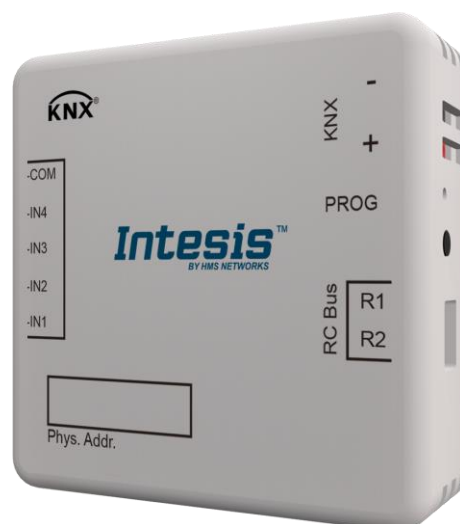

Gateway for integration of Panasonic/ Sanyo air conditioners
into KNX TP-1 (EIB) control systems
Compatible with ECOi, PACi and ECOg Series air conditioners commercialized by
Panasonic and Sanyo
Application's Program Version: 1.3

USER MANUAL

Issue date: 03/2020 r2.4 ENGLISH



Important User Information

Disclaimer

The information in this document is for informational purposes only. Please inform HMS Industrial Networks of any inaccuracies or omissions found in this document. HMS Industrial Networks disclaims any responsibility or liability for any errors that may appear in this document.

HMS Industrial Networks reserves the right to modify its products in line with its policy of continuous product development. The information in this document shall therefore not be construed as a commitment on the part of HMS Industrial Networks and is subject to change without notice. HMS Industrial Networks makes no commitment to update or keep current the information in this document.

The data, examples and illustrations found in this document are included for illustrative purposes and are only intended to help improve understanding of the functionality and handling of the product. In view of the wide range of possible applications of the product, and because of the many variables and requirements associated with any particular implementation, HMS Industrial Networks cannot assume responsibility or liability for actual use based on the data, examples or illustrations included in this document nor for any damages incurred during installation of the product. Those responsible for the use of the product must acquire sufficient knowledge in order to ensure that the product is used correctly in their specific application and that the application meets all performance and safety requirements including any applicable laws, regulations, codes and standards. Further, HMS Industrial Networks will under no circumstances assume liability or responsibility for any problems that may arise as a result from the use of undocumented features or functional side effects found outside the documented scope of the product. The effects caused by any direct or indirect use of such aspects of the product are undefined and may include e.g. compatibility issues and stability issues.

Gateway for integration of **Panasonic /Sanyo** air conditioners into KNX TP-1 (EIB) control systems. Compatible with ECOi, PACi and ECOg Series air conditioners commercialized by **Panasonic** and **Sanyo**.

Application's Program Version: 1.3

ORDER CODE	LEGACY ORDER CODE
INKNXPAN001R000	PA-RC2-KNX-1i

INDEX

1.	Presentation	6
2.	Connection	7
2.1	INKNXPAN001R000 with Panasonic Remote Controller	7
3.	Configuration and setup	7
4.	ETS Parameters	8
4.1	General dialog	9
4.1.1	Send READs for Control_ objects on bus recovery	9
4.1.2	Scene to load on bus recovery / startup	9
4.1.3	Disallow control from remote controller	9
4.1.4	Enable func "Control_ Lock Control Obj"	10
4.1.5	Enable func "Operating Hours Counter"	10
4.1.6	Enable use of objects for Filter	11
4.1.7	Enable object "Error Code [2byte]"	11
4.1.8	Enable object "Error Text Code [14byte]"	11
4.2	Mode Configuration dialog	12
4.2.1	Indoor unit has HEAT mode	12
4.2.2	Indoor unit has AUTO mode	12
4.2.3	When mode is AUTO Status_ objs report actual operating status	13
4.2.4	Enable "Mode Cool/Heat" objects	13
4.2.5	Enable PID-Compat. Scaling Mode Objects (for Control)	13
4.2.6	Enable use of + / - object for Mode	14
4.2.7	Enable use of bit-type Mode objects (for control)	15
4.2.8	Enable use of bit-type Mode objects (for status)	15
4.2.9	Enable use of Text object for Mode	15
4.3	Special Modes Configuration dialog	16
4.3.1	Enable use of POWER mode	16
4.3.2	Enable use of ECONOMY mode	17
4.3.3	Enable use of ADDITIONAL HEATING mode	18
4.3.4	Enable use of ADDITIONAL COOLING mode	19
4.4	Fan Speed Configuration dialog	19
4.4.1	DPT object type for fanspeed	20
4.4.2	Enable use of +/- object for Fan Speed	21
4.4.3	Enable "Fan Speed Man/Auto" objects (for Control and Status)	22
4.4.4	Enable use of bit-type Fan Speed objects (for Control)	22
4.4.5	Enable use of bit-type Fan Speed objects (for Status)	22
4.4.6	Enable use of Text object for Fan Speed	22
4.5	Vanes Up-Down Configuration dialog	23
4.5.1	Indoor unit has U-D Vanes	23
4.5.2	IU has following U-D Vanes values	24
4.5.3	DPT object type for Vanes Up-Down	24
4.5.4	Enable use of +/- object for Vanes U-D	25
4.5.5	Enable "Vanes U-D Standby" objects (for control and status)	26
4.5.6	Enable use of bit-type Vane U-D objects (for Control)	26
4.5.7	Enable use of bit-type Vane U-D objects (for Status)	27
4.5.8	Enable "Vanes U-D Standby" objects (for control and status)	27
4.5.9	Enable use of Text object for Vane U-D	28
4.6	Temperature Configuration dialog	28
4.6.1	Periodic sending of "Status_ AC Setp"	28
4.6.2	Transmission of "Status_ AC Ref Temp"	29
4.6.3	Enable use of +/- object for Setpoint Temp	29
4.6.4	Enable limits on Control_ Setpoint obj	30
4.6.5	Ambient temp. ref. is provided from KNX	30
4.7	Scene Configuration dialog	31
4.7.1	Enable use of scenes	31
4.7.2	Scenes can be stored from KNX bus	32
4.7.3	Enable use of bit objects for scene execution	32

- 4.7.4 Scene "x" preset 33
- 4.8 Switch-Off Timeouts Configuration dialog 34
 - 4.8.1 Enable use of Open Window / Switch off timeout function 35
 - 4.8.2 Enable use of Occupancy function 36
 - 4.8.3 Enable use of SLEEP timeout 38
- 4.9 Binary Input "x" Configuration dialog 39
 - 4.9.1 Enable use of Input "x" 39
 - 4.9.2 Contact type 39
 - 4.9.3 Debounce time 39
 - 4.9.4 Disabling function 40
 - 4.9.5 Function 40
- 5. Specifications 48
- 6. AC Unit Types compatibility 49
- 7. Error Codes 50
- 8. Appendix A – Communication Objects Table 55

1. Presentation



INKNXPAN001R000 allows a complete and natural integration of **Panasonic** and **Sanyo** air conditioners with KNX control systems.

Compatible with ECOi, PACi and ECOg Series air conditioners commercialized by **Panasonic** and **Sanyo**.

Main features:

- Reduced dimensions, quick installation.
- Multiple objects for control and status (bit, byte, characters...) with KNX standard datapoint types.
- Status objects for every control available.
- Timeout for Open Window and Occupancy. Sleep function also available.
- Control of the AC unit based in the ambient temperature read by the own AC unit, or in the ambient temperature read by any KNX thermostat.
- AC unit can be controlled simultaneously by the wired remote control of the AC unit and by KNX.
- Total Control and Monitoring of the AC unit from KNX, including monitoring of AC unit's state of internal variables, running hours counter (for filter maintenance control), and error indication and error code.
- Up to 5 scenes can be saved and executed from KNX, fixing the desired combination of Operation Mode, Set Temperature, Fan Speed, Vane Position and Remote Controller Lock in any moment by using a simple switching.
- Four binary inputs for potential-free contacts provide the possibility to integrate many types of external devices. Also configurable from ETS, they can be used for switching, dimming, shutter/blind control, and more

2. Connection

Connection of the INKNXPAN001R000 to the AC indoor unit

The INKNXPAN001R000 can be connected directly to the R1R2 bus of the indoor unit (no Panasonic remote controller -RC from now on- connected in the R1R2 bus) or with the Panasonic RC. See connection diagram below.

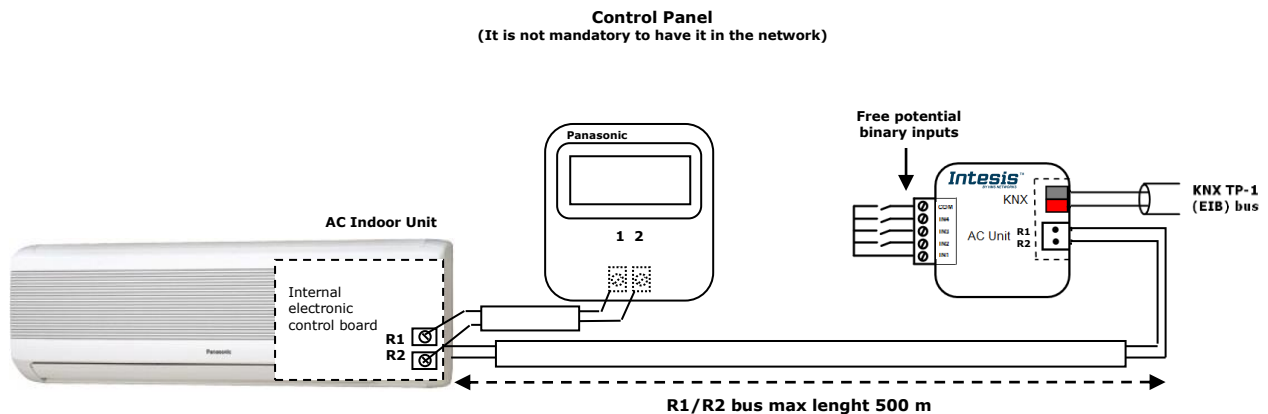

Figure 2.1 INKNXPAN001R000 connection diagrams

2.1 **INKNXPAN001R000 with Remote Controller**

Connection of the INKNXPAN001R000 to the KNX bus:

Disconnect power of the KNX bus. Connect the INKNXPAN001R000 to the KNX TP-1 (EIB) bus using the KNX standard connector (red/grey) of the INKNXPAN001R000, respect polarity.

Reconnect power of the KNX bus, and mains power of the AC unit.

NOTE: In some indoor unit models the R1/R2 is not available. In its place there is a pair of cables to connect the Remote Controller. Use these cables to connect the R1/R2 bus. Check your indoor unit user or service manual for more information.

3. Configuration and setup

This is a fully compatible KNX device which must be configured and setup using standard KNX tool ETS.

ETS database for this device can be downloaded from:

<https://intesis.com/products/ac-interfaces/panasonic-gateways/panasonic-knx-inputs-vrf-pa-rc2-knx-1i>

Please consult the README.txt file, located inside the downloaded zip file, to find instructions on how to install the database.

⚠ Important: Do not forget to select the correct settings of AC indoor unit being connected to the INKNXPAN001R000. This is in "Parameters" of the device in ETS.

4. ETS Parameters

When imported to the ETS software for the first time, the gateway shows the following default parameter configuration:

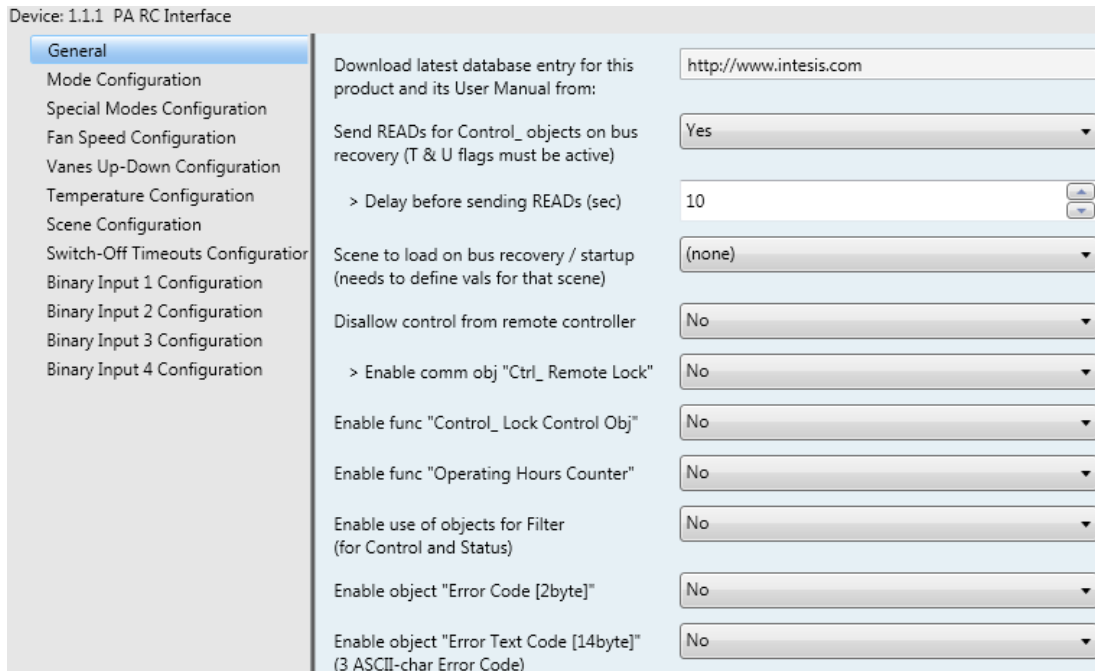

Figure 4.1 Default parameter configuration

With this configuration it's possible to send On/Off (*Control_ On/Off*), change the AC Mode (*Control_ Mode*), the Fan Speed (*Control_ Fan Speed*) and also the Setpoint Temperature (*Control_ Setpoint Temperature*). The Status_ objects, for the mentioned Control_ objects, are also available to use if needed. Also objects *Status_ AC Return Temp* and *Status_ Error/Alarm* are shown.

1.1.1 PA RC2 interface, 4 binary inputs	
0:	Control_ On/Off [DPT_1.001 - 1bit] - 0-Off;1-On
1:	Control_ Mode [DPT_20.105 - 1byte] - 0-Aut;1-Hea;3-Coo;9-Fan;14-Dry
11:	Control_ Fan Speed / 3 Speeds [DPT_5.001 - 1byte] - Thresholds: 50% and 83%
17:	Control_ Vanes U-D / 5 Pos [DPT_5.001 - 1byte] - Thresholds:30%,50%,70% and 90%
26:	Control_ Setpoint Temp [DPT_9.001 - 2byte] - °C
54:	Status_ On/Off [DPT_1.001 - 1bit] - 0-Off;1-On
55:	Status_ Mode [DPT_20.105 - 1byte] - 0-Aut;1-Hea;3-Coo;9-Fan;14-Dry
63:	Status_ Fan Speed / 3 Speeds [DPT_5.001 - 1byte] - 33%, 67% and 100%
69:	Status_ Vanes U-D / 5 Pos [DPT_5.001 - 1byte] - 20%, 40%, 60%, 80% and 100%
78:	Status_ AC Setpoint Temp [DPT_9.001 - 2byte] - °C
79:	Status_ AC Return Temp [DPT_9.001 - 2byte] - °C
81:	Status_ Error/Alarm [DPT_1.005 - 1bit] - 0-No alarm;1-Alarm
83:	Status_ Error Text Code [DPT_16.001 - 14byte] - 3-char PA Error; Empty-None

Figure 4.2 Default communication objects

4.1 General dialog

Inside this parameter's dialog it is possible to activate or change the parameters shown in the **Figure 4.1**.

The first field shows the URL where to download the database and the user manual for the product.

4.1.1 Send READs for Control_ objects on bus recovery

When this parameter is enabled, INKNXPAN001R000 will send READ telegrams for the group addresses associated on its *Control_* objects on bus recovery or application reset/start-up.

- If set to **"no"** the gateway will not perform any action.
- If set to **"yes"** all *Control_* objects with both Transmit **(T)** and Update **(U)** flags enabled will send READs and their values will be updated with the response when received.

Figure 4.3 Parameter detail

➤ Delay before sending READs (sec):

With this parameter, a delay can be configured between 0 and 30 seconds for the READs sent by the *Control_* objects. This is to give time enough to other KNX devices on the bus to start-up before sending the READs.

4.1.2 Scene to load on bus recovery / startup

This parameter executes a selected scene on bus recovery or startup, only if the selected scene has an enabled preset or values previously saved from KNX bus (see Scene Configuration dialog).

If the gateway is disconnected from the indoor unit the scene will not be applied, even when connecting to the indoor unit again.

Figure 4.4 Parameter detail

4.1.3 Disallow control from remote controller

This parameter allows:

- 1- Having the remote controller always locked, or
 - 2- Decide through a new communication object if the RC is locked or not.
- If set to **"yes"** all the actions performed through the remote controller will be disabled.

- If set to **"no"** the remote controller will work as usually. It also appears a new parameter and the communication object *Control_ Lock Remote Control*.

■ 33 Control_ Lock Remote Control [DPT_1.002 - 1bit] - 0-Unlocked;1-Locked

Disallow control from remote controller	no
> Enable comm obj "Ctrl_ Remote Lock"	yes

Figure 4.5 Communication object and parameter detail

➤ Enable comm obj "Ctrl_ Remote Lock":

If set to **"no"** the object will not be shown.

If set to **"yes"** the *Control_ Lock Remote Control* object will appear.

- When a **"1"** value is sent to this communication object, the remote controller is locked. To be unlocked a **"0"** value must be sent. The gateway remembers the last value received even if a KNX bus reset/failure happens.

⚠ **Important:** *If an initial scene is enabled and it has as Value for Remote Lock (unchanged) or unlocked, this would unlock the remote controller because the initial scene has priority over the Control_ Lock Remote Control communication object.*

4.1.4 Enable func "Control_ Lock Control Obj"

This parameter shows/hide the *Control_ Lock Control Obj* communication object which, depending on the sent value, locks or unlocks ALL the *Control_* communication objects except itself.

■ 34 Control_ Lock Control Objects [DPT_1.002 - 1bit] - 0-Unlocked;1-Locked

- If set to **"no"** the object will not be shown.
- If set to **"yes"** the *Control_ Lock Control Objects* object will appear.
 - When a **"1"** value is sent to this communication object, all the *Control_* objects will be locked. To unlock a **"0"** value must be sent, as the gateway remembers the last value received even if a KNX bus reset/failure happens.

4.1.5 Enable func "Operating Hours Counter"

This parameter shows/hides the *Status_ Operation Hour Counter* communication object which counts the number of operating hours for the INKNXPAN001R000.

■ 88 Status_ Operation Hour Counter [DPT_7.001 - 2byte] - Number of operating hours

- If set to **"no"** the object will not be shown.
- If set to **"yes"** the *Status_ Operation Hour Counter* object will appear.

- This object can be read and sends its status every time an hour is counted. The gateway keeps that count in memory and the status is sent also after a KNX bus reset/failure. Although this object is marked as a *Status_* object it also can be written to update the counter when needed. To reset the counter should be written a "0" value.
- ⚠ **Important:** *This object comes by default without the write (W) flag activated. If is necessary to write on it, this flag must be activated.*
- ⚠ **Important:** *This object will also return its status, every time a value is written, only if it's different from the existing one.*
- ⚠ **Important:** *If the stored value is 0 hours, the gateway will not send the status to KNX.*

4.1.6 Enable use of objects for Filter

This parameter shows/hides *Control_ Reset Filter* and *Status_ Filter Status* that lets reset the filter status and also monitor if there is a filter alarm.

- ↕ 29 *Control_ Reset Filter* [DPT_1.015 - 1bit] - 1-Reset filter
- ↕ 80 *Status_ Filter Status* [DPT_1.005 - 1bit] - 0-No alarm;1-Alarm

- If set to "no" the object will not be shown.
- If set to "yes" the *Control_ Reset Filter* y *Status_ Filter Status* objects will appear.
 - The *Status_* object will show a "0" value when there's no filter alarm, and a "1" value when the filter is full. Once the filter is cleaned, the alarm can be reset by sending a "1" value to the *Control_ Reset Filter* object.

4.1.7 Enable object "Error Code [2byte]"

This parameter shows/hides the *Status_ Error Code* communication object which shows the indoor unit errors, if occurred, in numeric format.

- ↕ 82 *Status_ Error Code* [2byte] - 0-No error /Any other see man.

- If set to "no" the object will not be shown.
- If set to "yes" the *Status_ Error Code* [2byte] object will appear.
 - This object can be read and also sends the indoor unit error, if occurred, in numeric format. If a "0" value is shown that means no error.

4.1.8 Enable object "Error Text Code [14byte]"

This parameter shows/hides the *Status_ Error Text Code* communication object which shows the indoor unit errors, if occurred, in text format.

- ↕ 83 *Status_ Error Text Code* [DPT_16.001 - 14byte] - 3-char PA Error; Empty-None

- If set to **"no"** the object will not be shown.
- If set to **"yes"** the *Status_ Error Text Code* object will appear.
 - This object can be read and also sends the indoor unit error, if occurred, in text format. The errors shown have the same format as at the remote controller and at the error list from the indoor unit manufacturer. If the object's value is empty that means no error.

4.2 Mode Configuration dialog

Device: 1.1.1 PA RC2 interface, 4 binary inputs

Configuration Option	Value
Indoor unit has HEAT mode (see docum. for your indoor unit)	Yes
Indoor unit has AUTO mode (see docum. for your indoor unit)	Yes
When mode is AUTO Status_obj's report actual operating status (HEAT/COOL/..)	No
Enable "Mode Cool/Heat" objects (for Control and Status)	No
Enable PID-Compat. Scaling Mode objects (for Control)	No
Enable use of +/- object for Mode	No
Enable use of bit-type Mode objects (for Control)	No
Enable use of bit-type Mode objects (for Status)	No
Enable use of Text object for Mode	No

Figure 4.6 Default Mode Configuration dialog

All the parameters in this section are related with the different mode properties and communication objects.

■ 1 Control_Mode [DTP_20.105 - 1byte] - 0-Aut;1-Hea;3-Coo;9-Fan;14-Dry

The byte-type communication object for Mode works with the DTP_20.105. Auto mode will be enabled with a **"0"** value, Heat mode with a **"1"** value, Cool mode with a **"3"** value, Fan mode with a **"9"** value and Dry mode with a **"14"** value.

4.2.1 Indoor unit has HEAT mode

This parameter has to be used to indicate if the indoor unit has the *heat mode* available.

- If set to **"no"**, the indoor unit doesn't have the *heat mode* available.
- If set to **"yes"**, the indoor unit has the *heat mode* available.

⚠ Important: Read the documentation of your indoor unit to check if it has HEAT mode available.

4.2.2 Indoor unit has AUTO mode

This parameter has to be used to indicate if the indoor unit has the *auto mode* available.

- If set to **"no"**, the indoor unit doesn't have the *auto mode* available.
- If set to **"yes"**, the indoor unit has the *auto mode* available.

Important: Read the documentation of your indoor unit to check if it has *AUTO mode* available.

4.2.3 When mode is AUTO Status_ objs report actual operating status

This parameter shows the real status of the indoor unit when Auto mode is enabled.

- If set to **"no"**, when the indoor unit is set to Auto mode, all the *Status_* objects concerning mode will only show Auto enabled.
- If set to **"yes"**, when the indoor unit is set to Auto mode, all the *Status_* objects concerning mode will show the real mode which the machine is working (Cool, Heat, Dry, Fan). In case of the bitfield objects, also the *Status_ Mode Auto* will be shown enabled with a **"1"** value.

4.2.4 Enable "Mode Cool/Heat" objects

This parameter shows/hides the *Control_* and *Status_ Mode Cool/Heat* communication objects.

```

■ ↕ 2 Control_ Mode Cool/Heat [DPT_1.100 - 1bit] - 0-Cool;1-Heat
■ ↕ 56 Status_ Mode Cool/Heat [DPT_1.100 - 1bit] - 0-Cool;1-Heat

```

- If set to **"no"** the objects will not be shown.
- If set to **"yes"** the *Control_* and *Status_ Mode Cool/Heat* objects will appear.
 - When a **"1"** value is sent to the *Control_* communication object, **Heat mode** will be enabled in the indoor unit, and the *Status_* object will return this value.
 - When a **"0"** value is sent to the *Control_* communication object, **Cool mode** will be enabled in the indoor unit, and the *Status_* object will return this value.

4.2.5 Enable PID-Compat. Scaling Mode Objects (for Control)

This parameter shows/hides the *Control_ Mode Cool & On* and *Control_ Mode Heat & On* communication objects.

```

■ ↕ 3 Control_ Mode Cool & On [DPT_5.001 - 1byte] - 0%-Off;0.1%-100%-On+Cool
■ ↕ 4 Control_ Mode Heat & On [DPT_5.001 - 1byte] - 0%-Off;0.1%-100%-On+Heat

```

- If set to **"no"** the objects will not be shown.
- If set to **"yes"** the *Control_ Mode Cool & On* and *Control_ Mode Heat & On* objects will appear.

- These objects provide compatibility with those KNX thermostats that control the demand of heating or cooling by using scaling (percentage) objects. In these thermostats, the percentage demand is meant to be applied on a fluid valve of the heating / cooling system.
- INKNXPAN001R000 device does not provide individual control on the internal parts of the indoor unit (as can be its compressor, refrigerant valves, etc.). Rather, it provides the same level of control as a (user) remote controller.
- Objects "Control_ Mode Cool & On" and "Control_ Mode Heat & On" intend to bring compatibility between thermostats oriented to the control of custom heating / cooling systems and ready-made AC indoor units, by applying the following logic:
 - Whenever a non-zero value (>0%) is received at "Control_ Mode Cool & On", indoor unit will switch On in COOL mode.
 - Whenever a non-zero value (>0%) is received at "Control_ Mode Heat & On", indoor unit will switch On in HEAT mode.
 - Latest updated object will define the operating mode
 - Indoor unit will switch off only when both objects become zero (0%) – or when an OFF is requested at object "0. On/Off [DPT_1.001 - 1bit]"

* **Important:** These objects function is only to send On/Off and Cool/Heat to the indoor unit. The PID (Inverter system) is calculated by the indoor unit itself. Please consider introducing an appropriate PID configuration to the external KNX thermostat to not interfere the indoor unit PID.

4.2.6 Enable use of + / - object for Mode

This parameter shows/hides the *Control_ Mode +/-* communication object which lets change the indoor unit mode by using two different datapoint types.

🔗 10 Control_ Mode +/- [DPT_1.007 - 1bit] - 0-Decrease;1-Increase

- If set to "no" the object will not be shown.
- If set to "yes" the *Control_ Mode +/-* object and a new parameter will appear.

Enable use of +/- object for Mode	yes
> DPT type for +/- Mode Object	0-Up / 1-Down [DPT_1.008]

Figure 4.7 Parameter detail

➤ DPT type for +/- Mode Object

This parameter lets choose between the datapoints **0-Up / 1-Down [DPT_1.008]** and **0-Decrease / 1-Increase [DPT_1.007]** for the *Control_ Mode +/-* object.

The sequence followed when using this object is shown below:



- Up / Increase
- Down / Decrease
- * If available

⚠ **Important:** Read the documentation of your indoor unit to check if it has HEAT mode available.

4.2.7 Enable use of bit-type Mode objects (for control)

This parameter shows/hides the bit-type *Control_ Mode* objects.

- ↕ 5 Control_ Mode Auto [DPT_1.002 - 1bit] - 1-Set AUTO mode
- ↕ 6 Control_ Mode Heat [DPT_1.002 - 1bit] - 1-Set HEAT mode
- ↕ 7 Control_ Mode Cool [DPT_1.002 - 1bit] - 1-Set COOL mode
- ↕ 8 Control_ Mode Fan [DPT_1.002 - 1bit] - 1-Set FAN mode
- ↕ 9 Control_ Mode Dry [DPT_1.002 - 1bit] - 1-Set DRY mode

- If set to **"no"** the objects will not be shown.
- If set to **"yes"** the *Control_ Mode* objects for Auto, Heat, Cool, Fan and Dry will appear. To activate a mode by using these objects a **"1"** value has to be sent.

4.2.8 Enable use of bit-type Mode objects (for status)

This parameter shows/hides the bit-type *Status_ Mode* objects.

- ↕ 57 Status_ Mode Auto [DPT_1.002 - 1bit] - 1-AUTO mode is active
- ↕ 58 Status_ Mode Heat [DPT_1.002 - 1bit] - 1-HEAT mode is active
- ↕ 59 Status_ Mode Cool [DPT_1.002 - 1bit] - 1-COOL mode is active
- ↕ 60 Status_ Mode Fan [DPT_1.002 - 1bit] - 1-FAN mode is active
- ↕ 61 Status_ Mode Dry [DPT_1.002 - 1bit] - 1-DRY mode is active

- If set to **"no"** the objects will not be shown.
- If set to **"yes"** the *Status_ Mode* objects for Auto, Heat, Cool, Fan and Dry will appear. When enabled, a mode will return a **"1"** through its bit-type object.

4.2.9 Enable use of Text object for Mode

This parameter shows/hides the *Status_ Mode Text* communication object.

- ↕ 62 Status_ Mode Text [DPT_16.001 - 14byte] - ASCII String

- If set to **"no"** the object will not be shown.
- If set to **"yes"** the *Status_ Mode Text* object will appear. Also, in the parameters, will be shown five text fields, one for each mode, that will let modify the text string displayed by the *Status_ Mode Text* when changing mode.

> String when mode is AUTO	AUTO
> String when mode is HEAT (if available)	HEAT
> String when mode is COOL	COOL
> String when mode is FAN	FAN
> String when mode is DRY	DRY

Figure 4.8 Parameter detail

4.3 Special Modes Configuration dialog

Figure 4.9 Default Special Modes Configuration dialog

The Special Modes can be parameterized through the ETS parameters dialog, and they can be used to give extra functionality.

- ⚠ **Important:** When executing any of the Special Modes the real state of the indoor unit will NOT be shown in KNX.
- ⚠ **Important:** When the predefined time for the Special Mode is finished or a **"0"** value is sent to stop it; the previous state will be recovered.
- ⚠ **Important:** If a value concerning On/Off, Mode, Fan Speed or Setpoint Temperature is received from KNX while any Special Mode is running (**"1"**), the Special Mode will stop and the previous state will be recovered. The value received will be also applied then.
- ⚠ **Important:** If a value concerning On/Off, Mode, Fan Speed or Setpoint Temperature is modified through the remote controller, the Special Mode will stop WITHOUT recovering the previous state. Then the real indoor unit state will be shown in KNX including the new value received through the remote controller.

4.3.1 Enable use of POWER mode

This parameter shows/hides the *Control_ Power Mode* and *Status_ Power Mode* communication objects. The Power Mode lets change the Setpoint Temperature and the Fan Speed within a given period of time.

- | 35 Control_ Power Mode [DPT_1.010 - 1bit] - 0-Stop;1-Start
- | 84 Status_ Power Mode [DPT_1.001 - 1bit] - 0-Off;1-On

- If set to **"no"** the objects will not be shown.
- If set to **"yes"** the *Control_ Power Mode* and *Status_ Power Mode* objects and new parameters will appear.

Enable use of POWER mode	yes
> Action time for this mode (minutes) (0 = permanent / unlimited)	2
> Setpoint delta increase (HEAT) or decrease (COOL) - in Celsius	2.0°C
> Fanspeed for this mode	SPEED 3 (if avail.)

Figure 4.10 Parameter detail

- When a **"1"** value is sent to the *Control_* communication object Power Mode will be enabled, and the *Status_* object will return this value.
- When a **"0"** value is sent to the *Control_* communication object, Power Mode will be disabled, and the *Status_* object will return this value.

⚠ **Important:** *This mode will ONLY work if the indoor unit is both turned on and in a Heat, Cool, Auto-Heat or Auto-Cool Mode.*

➤ Action time for this mode (minutes):

Duration of Power Mode, in minutes, once started.

➤ Setpoint delta increase (HEAT) or decrease (COOL) – in Celsius:

Number of degrees Celsius that will increase in Heat Mode, or decrease in Cool Mode, while in Power Mode.

➤ Fan Speed for this mode:

Fan Speed that will be set in the unit while in Power Mode.

4.3.2 Enable use of ECONOMY mode

This parameter shows/hides the *Control_ Econo Mode* and *Status_ Econo Mode* communication objects. The Econo Mode lets change the Setpoint Temperature and the Fan Speed within a given period of time.

- ↕ 36 Control_ Econo Mode [DPT_1.010 - 1bit] - 0-Stop;1-Start
- ↕ 85 Status_ Econo Mode [DPT_1.001 - 1bit] - 0-Off;1-On

- If set to **"no"** the objects will not be shown.
- If set to **"yes"** the *Control_ Econo Mode* and *Status_ Econo Mode* objects and new parameters will appear.
 - When a **"1"** value is sent to the *Control_* communication object, EconoMode will be enabled, and the *Status_* object will return this value.
 - When a **"0"** value is sent to the *Control_* communication object, EconoMode will be disabled, and the *Status_* object will return this value.

⚠ **Important:** *This mode will ONLY work if the indoor unit is both turned on and in a Heat, Cool, Auto-Heat or Auto-Cool Mode.*

➤ Action time for this mode (minutes):

Duration of EconoMode, in minutes, once started.

➤ Setpoint delta increase (HEAT) or decrease (COOL) – in Celsius:

Number of degrees Celsius that will increase in Heat Mode, or decrease in Cool Mode, while in EconoMode.

➤ Fan Speed for this mode:

Fan Speed that will be set in the unit while in EconoMode.

4.3.3 Enable use of ADDITIONAL HEATING mode

This parameter shows/hides the *Control_ Start Additional Heat Mode* and *Status_ Additional Heat Mode* communication objects. The Additional Heating Mode lets change the Setpoint Temperature and the Fan Speed within a given period of time.

- ↕ 37 Control_ Additional Heat [DPT_1.010 - 1bit] - 0-Stop;1-Start
- ↕ 86 Status_ Additional Heat [DPT_1.001 - 1bit] - 0-Off;1-On

- If set to **"no"** the objects will not be shown.
- If set to **"yes"** the *Control_ Start Additional Heat Mode* and *Status_ Additional Heat Mode* objects and new parameters will appear.
 - When a **"1"** value is sent to the *Control_* communication object, Additional Heating Mode will be enabled, and the *Status_* object will return this value.
 - When a **"0"** value is sent to the *Control_* communication object, Additional Heating Mode will be disabled, and the *Status_* object will return this value.

⚠ **Important:** *This mode will ALWAYS turn on the indoor unit in Heat mode.*

- Action time for this mode (minutes):
Duration of Additional Heating Mode, in minutes, once started.
- Setpoint temp for this mode (°C):
Setpoint temperature that will be applied while in Additional Heating Mode.
- Fan Speed for this mode:
Fan Speed that will be set in the unit while in Additional Heating Mode.

4.3.4 Enable use of ADDITIONAL COOLING mode

This parameter shows/hides the *Control_ Start Additional Cool Mode* and *Status_ Additional Cool Mode* communication objects. The Additional Heating Mode lets change the Setpoint Temperature and the Fan Speed within a given period of time.

- ↕ 38 Control_ Additional Cool [DPT_1.010 - 1bit] - 0-Stop;1-Start
- ↕ 87 Status_ Additional Cool [DPT_1.001 - 1bit] - 0-Off;1-On

- If set to **"no"** the objects will not be shown.
- If set to **"yes"** the *Control_ Start Additional Cool Mode* and *Status_ Additional Cool Mode* objects and new parameters will appear.
 - When a **"1"** value is sent to the *Control_* communication object, Additional Cooling Mode will be enabled, and the *Status_* object will return this value.
 - When a **"0"** value is sent to the *Control_* communication object, Additional Cooling Mode will be disabled, and the *Status_* object will return this value.

⚠ **Important:** This mode will ALWAYS turn on the indoor unit in Cool mode.

- Action time for this mode (minutes):
Duration of Additional Cooling Mode, in minutes, once started.
- Setpoint temp for this mode (°C):
Setpoint temperature that will be applied while in Additional Cooling Mode.
- Fan Speed for this mode:
Fan Speed that will be set in the unit while in Additional Cooling Mode.

4.4 Fan Speed Configuration dialog

Figure 4.11 Default Fan Speed Configuration dialog

All the parameters in this section are related with the Fan Speed properties and communication objects.

4.4.1 DPT object type for fanspeed

With this parameter is possible to change the DPT for the *Control_Fan Speed* and *Status_Fan Speed* byte-type communication objects. Datapoints Scaling (DPT_5.001) and Enumerated (DPT_5.010) can be selected.

⚠ Important: *The communication objects shown in this section may be different depending on the number of fan speeds available, although they all share the same communication object number.*

- When **“Enumerated [DPT 5.010]”** is selected, *Control_Fan Speed* and *Status_Fan Speed* communication objects for this DPT will appear.

- 11 Control_Fan Speed / 3 Speeds [DPT_5.010 - 1byte] - Speed values: 1,2,3
- 63 Status_Fan Speed / 3 Speeds [DPT_5.010 - 1byte] - Speed Values: 1,2,3

The first fan speed will be selected if a **“1”** is sent to the *Control_* object. The second one will be selected sending a **“2”**; the third one will be selected sending a **“3”**.

The *Status_* object will always return the value for the fan speed selected.

⚠ Important: *If a “0” value is sent to the Control_ object, the minimum fan speed will be selected. If a value bigger than “3” is sent to the Control_ object, then the maximum fan speed will be selected.*

- When **“Scaling [DPT 5.001]”** is selected, *Control_Fan Speed* and *Status_Fan Speed* communication objects for this DPT will appear.

- 11 Control_Fan Speed / 3 Speeds [DPT_5.001 - 1byte] - Thresholds: 50% and 83%
- 63 Status_Fan Speed / 3 Speeds [DPT_5.001 - 1byte] - 33%, 67% and 100%

The next table shows the range of values that can be sent through the *Control_* object and the value returned by the *Status_* object.

	Fan Speed 1	Fan Speed 2	Fan Speed 3
Control_	0% - 49%	50% - 82%	83% - 100%
Status_	33%	67%	100%

⚠ **Important:** Read the documentation of your indoor unit to check how many fan speeds are available.

4.4.2 Enable use of +/- object for Fan Speed

This parameter shows/hides the *Control_ Fan Speed +/-* communication object which lets increase/decrease the indoor unit fan speed by using two different datapoint types.

```
16 Control_ Fan Speed +/- [DPT_1.007 - 1bit] - 0-Decrease;1-Increase
```

- If set to **"no"** the object will not be shown.
- If set to **"yes"** the *Control_ Fan Speed +/-* object and a new parameter will appear.

The screenshot shows a configuration panel with four dropdown menus:

- Enable use of +/- object for Fan Speed: Yes
- > DPT type for +/- Fan Speed object: 0-Decrease / 1-Increase [DPT_1.007]
- > Does +/- sequence include fan speed AUTO?: No
- > Rollover Speed at upper/lower limit (when controlling with +/- obj): Yes

Figure 4.13 Parameter detail

➤ DPT type for +/- Fan Speed Object

This parameter lets choose between the datapoints **0-Up / 1-Down [DPT_1.008]** and **0-Decrease / 1-Increase [DPT_1.007]** for the *Control_ Fan Speed +/-* object.

➤ Does +/- sequence include fan speed Auto?

This parameter includes or excludes the auto mode for the fan speed in the list of available speeds.

➤ Roll-over Speed at upper/lower limit

This parameter lets choose if roll-over will be enabled (**"yes"**) or disabled (**"no"**) for the *Control_ Fan Speed +/-* object.

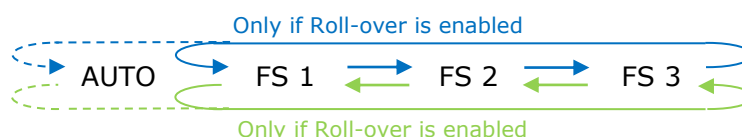

- Up / Increase
- Down / Decrease

4.4.3 Enable "Fan Speed Man/Auto" objects (for Control and Status)

This parameter shows/hides the bit-type *Control_ Fan Speed Man/Auto* and the *Status_ Fan Speed Man/Auto* objects.

- 12 Control_ Fan Speed Man/Auto [DPT_1.002 - 1bit] - 0-Manual; 1-Auto
- 64 Status_ Fan Speed Man/Auto [DPT_1.002 - 1bit] - 0-Manual; 1-Auto

4.4.4 Enable use of bit-type Fan Speed objects (for Control)

This parameter shows/hides the bit-type *Control_ Fan Speed* objects.

- 13 Control_ Fan Speed 1 [DPT_1.002 - 1bit] - 1-Set Fan Speed 1
- 14 Control_ Fan Speed 2 [DPT_1.002 - 1bit] - 1-Set Fan Speed 2
- 15 Control_ Fan Speed 3 [DPT_1.002 - 1bit] - 1-Set Fan Speed 3

- If set to **"no"** the objects will not be shown.
- If set to **"yes"** the *Control_ Fan Speed* objects for Speed 1, Speed 2 and Speed 3 will appear. To activate a Fan Speed by using these objects a **"1"** value has to be sent.

4.4.5 Enable use of bit-type Fan Speed objects (for Status)

This parameter shows/hides the bit-type *Status_ Fan Speed* objects.

- 65 Status_ Fan Speed 1 [DPT_1.002 - 1bit] - 1-Fan in Speed 1
- 66 Status_ Fan Speed 2 [DPT_1.002 - 1bit] - 1-Fan in Speed 2
- 67 Status_ Fan Speed 3 [DPT_1.002 - 1bit] - 1-Fan in Speed 3

- If set to **"no"** the objects will not be shown.
- If set to **"yes"** the *Status_ Fan Speed* objects for Speed 1, Speed 2 and Speed 3 will appear. When a Fan Speed is enabled, a **"1"** value is returned through its bit-type object.

4.4.6 Enable use of Text object for Fan Speed

This parameter shows/hides the *Status_ Fan Speed Text* communication object.

- 68 Status_ Fan Speed Text [DPT_16.001 - 14byte] - ASCII String

- If set to **"no"** the object will not be shown.
- If set to **"yes"** the *Status_ Fan Speed Text* object will appear. Also, in the parameters, will be shown five text fields, one for each Fan Speed, that will let modify the text string displayed by the *Status_ Fan Speed Text* when changing a fan speed.

> String when fan speed is AUTO	AUTO
> String when fan speed is 1	SPEED 1
> String when fan speed is 2	SPEED 2
> String when fan speed is 3	SPEED 3

Figure 4.14 Parameter detail

4.5 Vanes Up-Down Configuration dialog

Device: 1.1.1 PA RC2 interface, 4 binary inputs

General	Indoor unit has U-D Vanes (see docum. for your indoor unit)	Yes
Mode Configuration	IU has the following U-D Vanes values (see docum. for your indoor unit)	5 positions, SWING and STANDBY
Special Modes Configuration	DPT object type for Vanes Up-Down	Scaling [DPT_5.001]
Fan Speed Configuration	Enable use of +/- object for Vanes U-D	No
Vanes Up-Down Configuration	Enable "Vanes U-D Standby" objects (for Control and Status)	No
Temperature Configuration	Enable use of bit-type Vanes U-D objects (for Control)	No
Scene Configuration	Enable use of bit-type Vanes U-D objects (for Status)	No
Switch-Off Timeouts Configuration	Enable "Vanes U-D Swing" objects (for Control and Status)	No
Binary Input 1 Configuration	Enable use of Text object for Vanes U-D	No
Binary Input 2 Configuration		
Binary Input 3 Configuration		
Binary Input 4 Configuration		

Figure 4.15 Vanes Up-Down Configuration dialog

All the parameters in this section are related with the Vanes Up-Down properties and communication objects.

4.5.1 Indoor unit has U-D Vanes

This parameter lets choose if the unit has Up-Down Vanes available or not.

Indoor unit has U-D Vanes (see docum. for your indoor unit)	Yes
--	-----

Figure 4.16 Parameter detail

- If set to **"no"** all the parameters and communication objects for the Up-Down Vanes will not be shown.
- If set to **"yes"** all the parameters and communication objects (if enabled in the parameters dialog) for the Up-Down Vanes will be shown.

⚠ Important: Read the documentation of your indoor unit to check if Up-Down Vanes are available.

4.5.2 IU has following U-D Vanes values

This parameter lets choose if the unit has any of the two available modes for vanes directions.



Figure 4.16 Parameter detail

- If set to **"5 positions, SWING and STANDBY"** all the parameters and communication objects for the for the 5 Vanes positions will not be shown and communication objects only for SWING and STANDBY will be shown.
- If set to **"SWING and STANDBY"** all the parameters and communication objects (if enabled in the parameters dialog) for the 5 Vanes positions will be shown.

- 18 Control_Vanes U-D Standby [DPT_1.002 - 1bit] - 0-Off;1-Standby
- 24 Control_Vanes U-D Swing [DPT_1.002 - 1bit] - 0-Off;1-Swing
- 70 Status_Vanes U-D Standby [DPT_1.002 - 1bit] - 0-Off;1-Standby
- 76 Status_Vanes U-D Swing [DPT_1.002 - 1bit] - 0-Off;1-Swing

Important: Read the documentation of your indoor unit to check if Up-Down Vanes positions are available.

4.5.3 DPT object type for Vanes Up-Down

With this parameter is possible to change de DPT for the *Control_Vanes U-D* and *Status_Vanes U-D* byte-type communication objects. Datapoints Scaling (DPT_5.001) and Enumerated (DPT_5.010) can be selected.

⚠ Important: The communication objects shown in this section may be different depending on the number of vanes position available, although they all share the same communication object number.

- When **"Enumerated [DPT 5.010]"** is selected, *Control_Vanes U-D* and *Status_Vanes U-D* communication objects for this DPT will appear.

- 17 Control_Vanes U-D / 4 Pos [DPT_5.010 - 1byte] - Position values: 1,2,3,4
- 69 Status_Vanes U-D / 4 Pos [DPT_5.010 - 1byte] - Position values: 1,2,3,4

To choose a vanes position, values from **"1"** to **"4"** can be sent to the *Control_* object. Each value will correspond to the position (i.e. Value **"3"** = Position 3).

The *Status_* object will always return the value for the vane position selected.

⚠ Important: If a **"0"** value is sent to the *Control_* object, the Position 1 will be selected. If a value bigger than **"4"** is sent to the *Control_* object, then the higher Position will be selected.

- When “**Scaling [DPT 5.001]**” is selected, *Control_ Vane Up-Down* and *Status_ Vane Up-Down* communication objects for this DPT will appear.

- 17 *Control_ Vanes U-D / 5 Pos [DPT_5.001 - 1byte]* - Thresholds:30%,50%,70% and 90%
- 69 *Status_ Vanes U-D / 5 Pos [DPT_5.001 - 1byte]* - 20%, 40%, 60%, 80% and 100%

The next table shows the range of values that can be sent through the *Control_* object and the value returned by the *Status_* object.

	<i>Vanes Pos.1</i>	<i>Vanes Pos.2</i>	<i>Vanes Pos.3</i>	<i>Vanes Pos.4</i>	<i>Vanes Pos.4</i>
<i>Control_</i>	0% - 29%	30% - 49%	50% - 69%	70% - 89%	90% - 100%
<i>Status_</i>	20%	40%	60%	80%	100%

4.5.4 Enable use of +/- object for Vanes U-D

This parameter shows/hides the *Control_ Vane Up-Down +/-* communication object which lets change the indoor unit vane position by using two different datapoint types.

- 25 *Control_ Vanes U-D +/- [DPT_1.007 - 1bit]* - 0-Decrease;1-Increase

- If set to “**no**” the object will not be shown.
- If set to “**yes**” the *Control_ Vanes U-D +/-* object and a new parameter will appear.

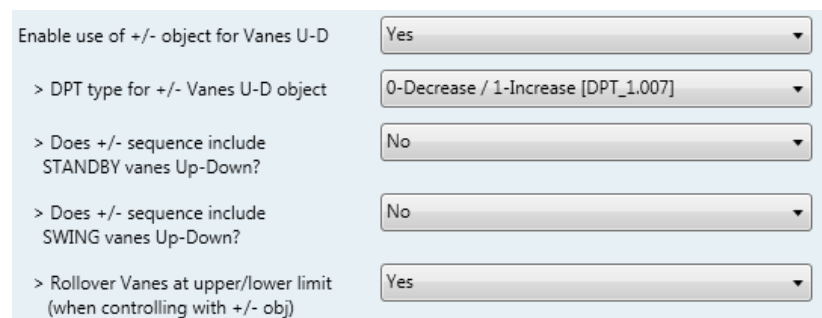

Figure 4.17 Parameter detail

➤ DPT type for +/- Vane Up-Down obj

This parameter lets choose between the datapoints **0-Up / 1-Down [DPT_1.008]** and **0-Decrease / 1-Increase [DPT_1.007]** for the *Control_ Vanes U-D +/-* object.

➤ Does +/- sequence include STANDBY vanes Up-Down?

This parameter lets choose if STANDBY function is included (“**yes**”) or not (“**no**”) in the sequence when using *Control_ Vanes U-D +/-* object as shown in the discontinuous segment at the picture below.

➤ Does +/- sequence include SWING vanes Up-Down?

This parameter lets choose if SWING function is included (“**yes**”) or not (“**no**”) in the sequence when using *Control_ Vanes U-D +/-* object as shown in the discontinuous segment at the picture below.

➤ Roll over Vanes at upper/lower limit

This parameter lets choose if roll-over will be enabled (“**yes**”) or disabled (“**no**”) for the *Control_ Vanes U-D +/-* object.

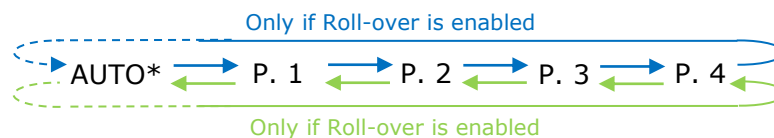

- Up / Increase
- Down / Decrease
- * If Available

4.5.5 Enable “Vanes U-D Standby” objects (for control and status)

This parameter will only be present if parameter on 4.5.2 is set to “5 positions, SWING and STANDBY”. It will show/hide *Control_ Vanes U-D Standby* y *Status_ Vanes U-D Standby* communication objects.

- 18 *Control_ Vanes U-D Standby* [DPT_1.002 - 1bit] - 0-Off;1-Standby
- 70 *Status_ Vanes U-D Standby* [DPT_1.002 - 1bit] - 0-Off;1-Standby

- If set to “**no**” the object will not be shown.
- If set to “**yes**” the *Control_ Vanes U-D Standby* y *Status_ Vanes Standby* objects will appear.
 - When a “**1**” value is sent to the *Control_* communication object, Vanes Up-Down will be in Auto mode and the *Status_* object will return this value.
 - When a “**0**” value is sent to the *Control_* communication object, Vanes Up-Down will be in Manual mode and the *Status_* object will return this value.
 - ⚠ **Important:** *When activating Auto Mode in the indoor unit, this one will choose the best position available for the Vanes Up-Down. This position will not be shown either in the KNX bus or in the remote controller.*
 - ⚠ **Important:** *Read the documentation of your indoor unit to check how many AUTO modes are available.*

4.5.6 Enable use of bit-type Vane U-D objects (for Control)

This parameter shows/hides the bit-type *Control_ Vanes U-D* objects.

- ↕ 19 Control_Vanes U-D Pos 1 [DPT_1.002 - 1bit] - 1-Set Position 1
- ↕ 20 Control_Vanes U-D Pos 2 [DPT_1.002 - 1bit] - 1-Set Position 2
- ↕ 21 Control_Vanes U-D Pos 3 [DPT_1.002 - 1bit] - 1-Set Position 3
- ↕ 22 Control_Vanes U-D Pos 4 [DPT_1.002 - 1bit] - 1-Set Position 4
- ↕ 23 Control_Vanes U-D Pos 5 [DPT_1.002 - 1bit] - 1-Set Position 5

- If set to **"no"** the objects will not be shown.
- If set to **"yes"** the *Control_Vanes U-D* objects for each Position will appear. To activate a Vanes Position by using these objects, a **"1"** value has to be sent.

4.5.7 Enable use of bit-type Vane U-D objects (for Status)

This parameter shows/hides the bit-type *Status_Vanes U-D* objects.

- ↕ 71 Status_Vanes U-D Pos 1 [DPT_1.002 - 1bit] - 1-Vanes in Position 1
- ↕ 72 Status_Vanes U-D Pos 2 [DPT_1.002 - 1bit] - 1-Vanes in Position 2
- ↕ 73 Status_Vanes U-D Pos 3 [DPT_1.002 - 1bit] - 1-Vanes in Position 3
- ↕ 74 Status_Vanes U-D Pos 4 [DPT_1.002 - 1bit] - 1-Vanes in Position 4
- ↕ 75 Status_Vanes U-D Pos 5 [DPT_1.002 - 1bit] - 1-Vanes in Position 5

- If set to **"no"** the objects will not be shown.
- If set to **"yes"** the *Status_Vanes U-D* objects for each Position will appear. When a Vanes Position is enabled, a **"1"** value is returned through its bit-type object.

4.5.8 Enable "Vanes U-D Standby" objects (for control and status)

This parameter will only be present if parameter on 4.5.2 is set to "5 positions, SWING and STANDBY". It will show/hide *Control_Vanes U-D SWING* y *Status_Vanes U-D SWING* communication objects.

- ↕ 24 Control_Vanes U-D Swing [DPT_1.002 - 1bit] - 0-Off;1-Swing
- ↕ 76 Status_Vanes U-D Swing [DPT_1.002 - 1bit] - 0-Off;1-Swing

- If set to **"no"** the object will not be shown.
- If set to **"yes"** the *Control_Vanes U-D Swing* y *Status_Vanes U-D Swing* objects will appear.
 - When a **"1"** value is sent to the *Control_* communication object, Vanes Up-Down will be in Auto mode and the *Status_* object will return this value.
 - When a **"0"** value is sent to the *Control_* communication object, Vanes Up-Down will be in Manual mode and the *Status_* object will return this value.
- ⚠ **Important:** *When activating Auto Mode in the indoor unit, this one will choose the best position available for the Vanes Up-Down. This position will not be shown either in the KNX bus or in the remote controller.*
- ⚠ **Important:** *Read the documentation of your indoor unit to check how many vanes modes are available.*

4.5.9 Enable use of Text object for Vane U-D

This parameter shows/hides the *Status_ Vanes U-D Text* communication object.

➡ 77 Status_ Vanes U-D Text [DPT_16.001 - 14byte] - ASCII String

- If set to **"no"** the object will not be shown.
- If set to **"yes"** the *Status_ Vanes U-D Text* object will appear. Also, in the parameters will be shown seven text fields, five for the Vane Position and one for the Auto function and another one for the Swing function, that will let modify the text string displayed by the *Status_ Vanes U-D Text* when changing a vane position.

> String when vanes U-D in STANDBY	U-D STANDBY
> String when vanes U-D in POS 1 (if available)	U-D POS 1
> String when vanes U-D in POS 2 (if available)	U-D POS 2
> String when vanes U-D in POS 3 (if available)	U-D POS 3
> String when vanes U-D in POS 4 (if available)	U-D POS 4
> String when vanes U-D in POS 5 (if available)	U-D POS 5
> String when vanes U-D in SWING	U-D SWING

Figure 4.19 Parameter detail

4.6 Temperature Configuration dialog

Device: 1.1.1 PA RC2 interface, 4 binary inputs

General	Periodic sending of "Status_ AC Setp" (in seconds;0=No periodic sending)	0
Mode Configuration	Transmission of "Status_ AC Return Temp"	Only on change
Special Modes Configuration	Enable use of +/- obj for Setpoint Temp	No
Fan Speed Configuration	Enable limits on Control_ Setpoint obj	No
Vanes Up-Down Configuration	Ambient temp. ref. is provided from KNX (carefully read User Guide if enabled)	No
Temperature Configuration		
Scene Configuration		
Switch-Off Timeouts Configuration		
Binary Input 1 Configuration		
Binary Input 2 Configuration		
Binary Input 3 Configuration		
Binary Input 4 Configuration		

Figure 4.20 Default Temperature Configuration dialog

All the parameters in this section are related with the Temperature properties and communication objects.

4.6.1 Periodic sending of "Status_ AC Setp"

This parameter lets change the interval of time (in seconds, from 0 to 255) at the end of which the AC setpoint temperature is sent to the KNX bus. For a **"0"** value, the AC setpoint temperature will ONLY be sent on change. The AC setpoint temperature is sent through the communication object *Status_ AC Setpoint Temp*.

➡ 78 Status_ AC Setpoint Temp [DPT_9.001 - 2byte] - (°C)

Periodic sending of "Status_ AC Setp" (in seconds; 0 = No periodic sending)	255	<input type="button" value="↑"/> <input type="button" value="↓"/>
--	-----	--

Figure 4.21 Parameter detail

⚠ **Important:** In case the ambient temperature is provided from KNX, the setpoint temperature returned from this object, will be the one resulting from the formula shown in the section "4.6.4 Ambient temp. ref. is provided from KNX".

4.6.2 Transmission of "Status_ AC Ref Temp"

This parameter lets to you choose if the AC return temperature will be sent **"only cyclically"**, **"only on change"** or **"cyclically and on change"**. The AC return temperature is sent through the communication object *Status_ AC Return Temp*.

🔗 79: Status_ AC Return Temp [DPT_9.001 - 2byte] - °C

Transmission of "Status_ AC Return Temp"	Cyclically and on change	<input type="button" value="↑"/> <input type="button" value="↓"/>
> "Status_ AC Return Temp" periodic sending time (in sec)	180	<input type="button" value="↑"/> <input type="button" value="↓"/>

Figure 4.22 Parameter detail

➤ "Status_ AC SetTemp" periodic sending time (in sec)

This parameter will only be available for the **"only cyclically"** and **"cyclically and on change"** options, and lets you change the interval of time (in seconds, from 1 to 255) at the end of which the AC return temperature is sent to the KNX bus.

4.6.3 Enable use of +/- object for Setpoint Temp

This parameter shows/hides the *Control_ Setpoint Temp +/-* communication object which lets change the indoor unit setpoint temperature by using two different datapoint types.

🔗 27 Control_ Setpoint Temp +/- [DPT_1.007 - 1bit] - 0-Decrease;1-Increase





- If set to **"no"** the object will not be shown.
- If set to **"yes"** the *Control_ Setpoint Temp +/-* object and a new parameter will appear.

Enable use of +/- obj for Setp Temp	yes	<input type="button" value="↑"/> <input type="button" value="↓"/>
> DPT type for +/- Setp Temp object	0-Up / 1-Down [DPT_1.008]	<input type="button" value="↑"/> <input type="button" value="↓"/>

Figure 4.22 Parameter detail

➤ DPT type for +/- Setp Temp object

This parameter lets choose between the datapoints **0-Up / 1-Down [DPT_1.008]** and **0-Decrease / 1-Increase [DPT_1.007]** for the *Control_ Setpoint Temp +/-* object.

(Lower limit) **18°C**  19°C  ...  28°C  **27°C** (Upper limit)

- Up / Increase
- Down / Decrease

4.6.4 Enable limits on Control_ Setpoint obj

This parameter enables to define temperature limits for the *Control_ Setpoint Temperature* object.

Enable limits on Control_ Setpoint obj	Yes
> Lower limit (°C)	18.0 °C
> Upper limit (°C)	27.0 °C

Figure 4.23 Parameter detail

- If set to **"no"** the setpoint temperature limits for the *Control_ Setpoint Temperature* object will be the default: 16°C for the lower limit and 31°C for the upper limit.
- If set to **"yes"** it is possible to define temperature limits for the *Control_ Setpoint Temperature* object.

➤ Control_ Set Temp Lower limit (°C)

This parameter lets to define the lower limit for the setpoint temperature.

➤ Control_ Set Temp Upper limit (°C)

This parameter lets to define the upper limit for the setpoint temperature.

⚠ Important: *If a setpoint temperature above the upper defined limit (or below the lower defined limit) is sent through the Control_ Setpoint Temperature object, it will be ALWAYS applied the limit defined.*

⚠ Important: *When limits are enabled, any setpoint temperature sent to the AC (even through scenes, special modes, etc.) will be limited.*

4.6.5 Ambient temp. ref. is provided from KNX

This parameter shows/hides the *Control_ Ambient Temperature* communication object which lets use an ambient temperature reference provided by a KNX device.

 28 Control_ Ambient Temperature [DPT_9.001 - 2byte] - (°C)

- If set to **"no"** the object will not be shown.
- If set to **"yes"** the *Control_ Ambient Temperature* object will appear. Meant to be enabled when you want the temperature provided by a KNX sensor to be the reference

ambient temperature for the air conditioner. Then, the following formula applies for calculation of real *Control_Setpoint Temperature* sent to the AC unit:

$$\text{"AC Setp. Temp"} = \text{"AC Ret. Temp"} - (\text{"KNX Amb.Temp."} - \text{"KNX Setp. Temp"})$$

- AC Setp. Temp.: AC indoor unit setpoint temperature
- AC Ret. Temp.: Ambient temperature provided from KNX
- KNX Amb. Temp.: Ambient temperature provided from KNX
- KNX Setp. Temp.: Setpoint temperature provided from KNX

As an example, consider the following situation:

User wants: **19°C** ("KNX Setp. Temp.")

User sensor (a KNX sensor) reads: **21°C** ("KNX Amb Temp.")

Ambient temp. read by Panasonic system is: **24°C** ("AC Ret. Temp")

In this example, the final setpoint temperature that INKNXPAN001R000 will send out to the indoor unit (shown in "Setp. Temp.") will become $24^{\circ}\text{C} - (21^{\circ}\text{C} - 19^{\circ}\text{C}) = 22^{\circ}\text{C}$.

This is the setpoint that will actually be requested to Panasonic unit.

This formula will be applied as soon as the *Control_Setpoint Temperature* and *Control_Ambient Temperature* objects are written at least once from the KNX installation. After that, they are kept always consistent.

Note that this formula will always drive the AC indoor unit demand in the *right* direction, regardless of the operation mode (Heat, Cool or Auto).

4.7 Scene Configuration dialog

Device: 1.1.1 PA RC Interface	
General	Enable use of scenes: Yes
Mode Configuration	Scenes can be stored from KNX bus: No
Special Modes Configuration	Enable use of bit objects for scene execution: No
Fan Speed Configuration	Scene 1 preset: No
Vanes Up-Down Configuration	Scene 2 preset: No
Temperature Configuration	Scene 3 preset: No
Scene Configuration	Scene 4 preset: No
Switch-Off Timeouts Configuration	Scene 5 preset: No
Binary Input 1 Configuration	
Binary Input 2 Configuration	
Binary Input 3 Configuration	
Binary Input 4 Configuration	

Figure 4.24 Parameter detail

All the parameters in this section are related with the Scene properties and communication objects. A scene contains values of: On/Off, Mode, Fan speed, Vane position, Setpoint Temperature and Remote Controller Disablement.

4.7.1 Enable use of scenes

This parameter shows/hides the scene configuration parameters and communication objects.

39 Control_ Execute Scene [DPT_18.001 - 1byte] - 0.4-Execute Scene 1-5

Enable use of scenes: yes

Figure 4.25 Parameter detail

- If set to **"no"** the scene parameters and communication objects will not be shown.
- If set to **"yes"** the scene parameters and communication objects will be shown. To execute a scene through the byte-type object, a value from **"0"** to **"4"** has to be sent, corresponding each one to a different scene (i.e. "0" = Scene 1;... "4" = Scene 5).

4.7.2 Scenes can be stored from KNX bus

This parameter shows/hides the *Control_ Save/Exec Scene* and all the *Control_ Store Scene* (if enabled) communication objects.

■ 39 Control_ Save/Exec Scene [DPT_18.001 - 1byte] - 0..4-Exec1-5;128..132-Save1-5

- If set to **"no"** the communication objects will not be shown.
- If set to **"yes"** the communication objects and a new parameter will appear. To store a scene through the byte-type object, a value from **"128"** to **"132"** has to be sent to the object, corresponding each one to a different scene (i.e. "128" = Scene 1;... "132" = Scene 5).

Scenes can be stored from KNX bus

> Enable use of bit objects for storing scenes (from bus)

Figure 4.26 Parameter detail

➤ Enable use of bit objects for storing scenes (from bus)

If set to **"no"** the objects will not be shown.

If set to **"yes"** the *Control_ Store Scene* objects for storing scenes will appear. To store a scene by using these objects, a **"1"** value has to be sent to the scene's object we want to store (i.e. to store scene 4, a "1" has to be sent to the *Control_ Store Scene 4* object).

■ 40 Control_ Store Scene 1 [DPT_1.002 - 1bit] - 1-Store Scene 1
 ■ 41 Control_ Store Scene 2 [DPT_1.002 - 1bit] - 1-Store Scene 2
 ■ 42 Control_ Store Scene 3 [DPT_1.002 - 1bit] - 1-Store Scene 3
 ■ 43 Control_ Store Scene 4 [DPT_1.002 - 1bit] - 1-Store Scene 4
 ■ 44 Control_ Store Scene 5 [DPT_1.002 - 1bit] - 1-Store Scene 5

4.7.3 Enable use of bit objects for scene execution

This parameter shows/hides the *Control_ Execute Scene* bit-type communication objects.

Enable use of bit objects for scene execution

Figure 4.27 Parameter detail

- If set to **"no"** the communication objects will not be shown.
- If set to **"yes"** the communication objects will appear. To execute a scene by using these objects, a **"1"** value has to be sent to the scene's object we want to execute (i.e. to execute scene 4, a **"1"** has to be sent to the *Control_ Execute Scene 4* object).

- ↕ 45 Control_ Execute Scene 1 [DPT_1.002 - 1bit] - 1-Execute Scene 1
- ↕ 46 Control_ Execute Scene 2 [DPT_1.002 - 1bit] - 1-Execute Scene 2
- ↕ 47 Control_ Execute Scene 3 [DPT_1.002 - 1bit] - 1-Execute Scene 3
- ↕ 48 Control_ Execute Scene 4 [DPT_1.002 - 1bit] - 1-Execute Scene 4
- ↕ 49 Control_ Execute Scene 5 [DPT_1.002 - 1bit] - 1-Execute Scene 5

4.7.4 Scene "x" preset

This parameter lets define a preset for a scene (the following description is valid for all the scenes).

Scene 1 preset	yes (scene will NOT be modifiable from KNX bus) ▾
----------------	---

Figure 4.28 Parameter detail

- If set to **"no"** the preset for the scene "x" will be disabled.
- If set to **"yes"** the preset will be enabled. When a scene is executed the values configured in the preset will be applied.

⚠ **Important:** If a scene's preset is enabled, will not be possible to modify (store) the scene from the KNX bus.

> Scene 1 / Value for On-Off	ON ▾
> Scene 1 / Value for Mode	COOL ▾
> Scene 1 / Value for Fan Speed	FAN SPEED AUTO ▾
> Scene 1 / Value for Vanes U-D (if available)	(unchanged) ▾
> Scene 1 / Value for Setpoint Temp	18.0 °C ▾
> Scene 1 / Value for Remote Lock	Locked (remote not allowed) ▾

Figure 4.29 Parameter detail

➤ Scene "x" / Value for On-Off

This parameter lets choose the power of the indoor unit when the scene is executed. The following options are available: **"ON"**, **"OFF"** or **"(unchanged)"**.

➤ Scene "x" / Value for Mode

This parameter lets choose the mode of the indoor unit when the scene is executed. The following options are available: **"AUTO(if available)"**, **"HEAT(if available)"**, **"COOL"**, **"FAN"**, **"DRY"**, or **"(unchanged)"**.

➤ Scene "x" / Value for Fan Speed

This parameter lets choose the fan speed of the indoor unit when the scene is executed. The following options are available: **"FAN SPEED AUTO"**, **"FAN SPEED 1"**, **"FAN SPEED 2"**, **"FAN SPEED 3"**, or **"(unchanged)"**.

➤ Scene "x" / Value for Vane U-D (if available)

This parameter lets choose the vane position of the indoor unit when the scene is executed. The following options are available: **"VANES U-D STANDBY"**, **"VANES U-D POS 1(if available)"**, **"VANES U-D POS 2(if available)"**, **"VANES U-D POS 3(if available)"**, **"VANES U-D POS 4(if available)"**, **"VANES U-D SWING"** or **"(unchanged)"**.

➤ Scene "x" / Value for Setpoint Temp (°C)

This parameter lets choose the setpoint temperature of the indoor unit when the scene is executed. The following options are available: from **"18°C"** to **"27°C"** (both included) or **"(unchanged)"**.

➤ Scene "x" / Value for Remote Lock

This parameter lets choose the remote controller status of the indoor unit when the scene is executed. The following options are available: **"Locked (remote not allowed)"**, **"unlocked (remote allowed)"** or **"(unchanged)"**.

⚠ **Important:** If any preset value is configured as **"(unchanged)"**, the execution of this scene will not change current status of this feature in the AC unit.

⚠ **Important:** When a scene is executed, *Status_ Current Scene* object shows the number of this scene. Any change in previous items does *Status_ Current Scene* show **"No Scene"**. Only changes on items marked as **"(unchanged)"** will not disable current scene.

4.8 Switch-Off Timeouts Configuration dialog

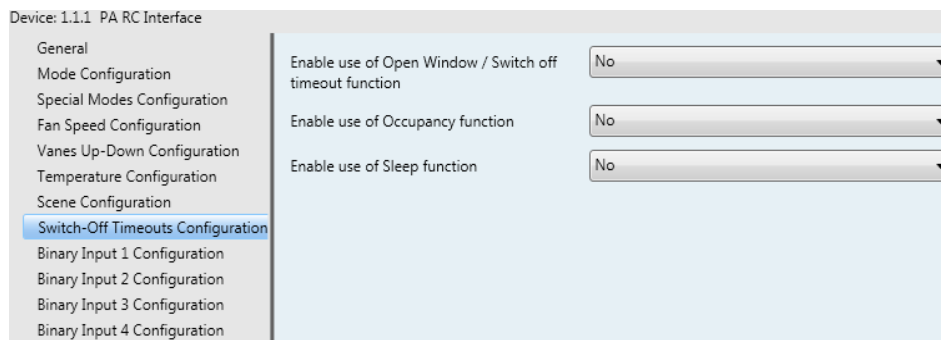

Figure 4.30 Default Switch-Off Timeouts Configuration dialog

All the parameters in this section are related with the timeout properties and communication objects.

4.8.1 Enable use of Open Window / Switch off timeout function

This parameter shows/hides the *Control_ Switch Off Timeout* communication object which lets Start/Stop a timeout to switch off the indoor unit.

- 30 Control_ Switch Off Timeout [DPT_1.010 - 1bit] - 0-Stop;1-Start
- 30 Control_ Window Contact Status [DPT_1.009 - 1bit] - 0-Open;1-Closed

- If set to **"no"** the object will not be shown.
- If set to **"yes"** the *Control_ Switch Off Timeout* object and new parameters will appear. If a **"1"** value is sent to this object, and the indoor unit is already turned on, the switch-off timeout will begin. If a **"0"** value is sent to this object, the switch-off timeout will stop.

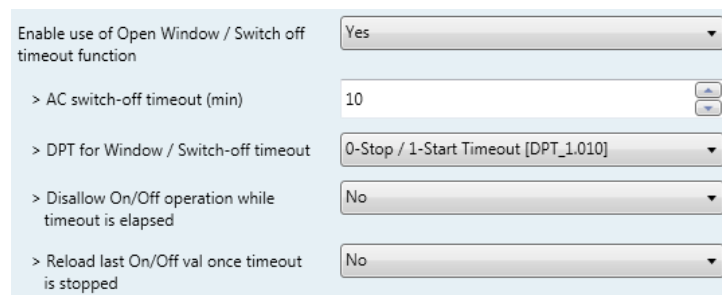

Figure 4.31 Parameter detail

➤ AC switch-off timeout (min)

This parameter lets select how much time (in minutes) to wait before switching off the indoor unit.

➤ DPT for Window / Switch-off timeout

This parameter lets choose between the datapoints **0-Open / 1-Closed Window [DPT_1.009]** and **0-Stop / 1-Start Timeout [DPT_1.010]** for the *Control_ Switch Off Timeout*.

➤ Disallow On/Off operation while window is Open

If set to **"no"**, On/Off commands while the window is open will be accepted.

- If a **"1"** value is sent to the *Control_ Switch Off Timeout* object the switch-off timeout period will begin again.
- If a **"0"** value is sent to the *Control_ Switch Off Timeout* object, no action will be performed.

If set to **"yes"**, On/Off commands, while the window is open, will be saved (but not applied). These commands will be used in the next parameter if set to **"yes"**.

➤ Reload last On/Off val once window is closed?

If set to **"no"**, once the switch-off timeout is stopped, any value will be reloaded.

If set to **"yes"**, once the switch-off timeout is stopped, the last On/Off value sent will be reloaded.

- If a **"1"** value is sent to the *Control_ Switch Off Timeout* object after the timeout period, the indoor unit will **turn on**.
- If a **"0"** value is sent to the *Control_ Switch Off Timeout* after the timeout period, no action will be performed.

4.8.2 Enable use of Occupancy function

This parameter shows/hides the *Control_ Occupancy* communication object which lets apply different parameters to the indoor unit depending on the presence/no presence in the room.

🔗 31 Control_ Occupancy [DPT_1.018 - 1bit] - 0-Not Occupied;1-Occupied

- If set to **"no"** the object will not be shown.
- If set to **"yes"** the *Control_ Occupancy* object and new parameters will appear. If a **"1"** value is sent to this object (no room occupancy), the timeout will begin. If a **"0"** value is sent to this object, the timeout will stop.

Enable use of Occupancy function	Yes
> Timeout to apply action (minutes)	20
> Action after timeout elapsed	Switch-Off AC
> Disallow On/Off operation while not Occupied	No
> Reload last On/Off value when Occupied	No

Figure 4.32 Parameter detail

➤ Timeout to apply action (minutes)

This parameter lets choose how much time to wait (in minutes) before executing the action specified in the next parameter ("Action after timeout elapsed").

➤ Action after timeout elapsed

When **Switch-Off** is selected, once the timeout has elapsed, the indoor unit will be turned off.

When **Apply Preset Delta** is selected, once the timeout has elapsed, a delta temperature will be applied to save energy (decreasing the setpoint when in Heat mode or increasing the setpoint when in Cool mode). Also new parameters will appear.

Figure 4.33 Parameter detail

➤ Temp delta decrease (HEAT) or increase (COOL) (°C)

This parameter lets configure the delta temperature (increase or decrease) that will be applied when the timeout has elapsed.

⚠ Important: When there is occupancy again after the application of a delta, the same delta will be applied inversely. (i.e. In a room with AC in cool mode and 25°C setpoint temperature, a **+2°C** delta is applied after the occupancy timeout, setting the setpoint at 27°C because there is no occupancy in the room. If the setpoint is raised to 29°C during that period, when the room is occupied again, a **-2°C** delta will be applied and the final setpoint temperature will then be 27°C).

➤ Enable secondary timeout

If set to **"no"** nothing will be applied.

If set to **"yes"**, a new timeout will be enabled, and two new parameters will appear.

Figure 4.34 Parameter detail

➤ Timeout to apply action (minutes)

This parameter lets choose how much time to wait (in minutes) before executing the action specified in the next parameter ("Action after timeout elapsed"). This time is considered as a part of the occupancy.

➤ Action after timeout elapsed

When **Switch-Off** is selected, once the timeout has elapsed, the indoor unit will turn off.

When **Apply Preset Delta** is selected, once the timeout configured is extinguished, a delta temperature will be applied (decreasing the setpoint when in Heat mode or increasing the setpoint when in Cool mode). Also new parameters will appear.

➤ Temp delta decrease (HEAT) or increase (COOL) (°C)

This parameter lets configure the delta temperature that will be applied when the timeout is extinguished.

⚠ **Important:** When there is occupancy again after the application of a delta, the same delta will be applied inversely as explained above.

➤ Disallow On/Off operation while not Occupied

If set to **"no"**, On/Off commands while the window is open will be accepted.

If set to **"yes"**, once **Switch-Off** action has been executed, On/Off commands will be saved (but not applied). These commands will be used in the next parameter if set to **"yes"**.

The screenshot shows two dropdown menus. The first is labeled '> Reload last On/Off value when Occupied' and is set to 'yes'. The second is labeled '> Disallow On/Off operation while not Occupied' and is also set to 'yes'.

Figure 4.35 Parameter detail

Consider that the countdown time (transitional time between occupancy and non-occupancy) is considered as a part of the occupancy status as explained before.

➤ Reload last On/Off value when Occupied

If set to **"no"**, once the switch-off timeout has elapsed, any value will be reloaded.

If set to **"yes"**, once the switch-off timeout has elapsed, the last On/Off value will be reloaded.

- If a **"1"** value is sent to the *Control_ Occupancy* object after the timeout period, the indoor unit will **turn on**.
- If a **"0"** value is sent to the *Control_ Occupancy* after the timeout period no action will be performed.

4.8.3 Enable use of SLEEP timeout

This parameter shows/hides the *Control_ Sleep Timeout* communication object which lets start a timeout to automatically turn off the indoor unit.

➤ 32 Control_ Sleep Timeout [DPT_1,010 - 1bit] - 0-Stop;1-Start

- If set to **"no"** the object will not be shown.
- If set to **"yes"** the *Control_ Sleep Timeout* object and a new parameter will appear. If a **"1"** value is sent to this object the switch-off timeout will begin. If a **"0"** value is sent to this object, the switch-off timeout will stop.

The screenshot shows a dropdown menu set to 'yes' for 'Enable use of SLEEP timeout'. Below it is a numeric input field for '> Sleep function switch-off timeout (minutes)' with the value '1' and up/down arrow buttons.

Figure 4.36 Parameter detail

- Timeout to apply action (minutes)

This parameter lets select how much time (in minutes) to wait before switching off the AC unit.

4.9 Binary Input "x" Configuration dialog

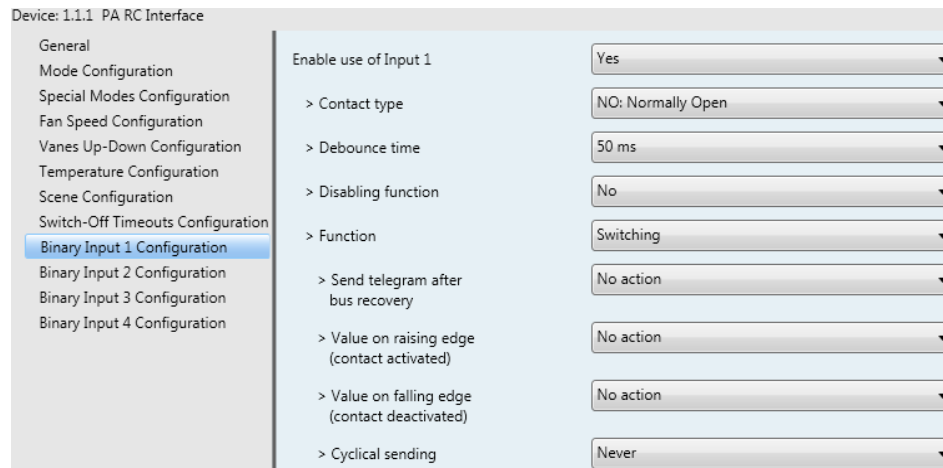

Figure 4.37 Binary Input Configuration dialog

All the parameters in this section are related with the binary inputs properties and communication objects.

4.9.1 Enable use of Input "x"

This parameter enables the use of the Input "x" and shows/hides the *Status_Inx* communication object(s) which will act as configured in the "Function" parameter.

- 90 Status_In1 - Switching [DPT_1.001 - 1bit] - 0-Off;1-On
- 92 Status_In2 - Switching [DPT_1.001 - 1bit] - 0-Off;1-On
- 94 Status_In3 - Switching [DPT_1.001 - 1bit] - 0-Off;1-On
- 96 Status_In4 - Switching [DPT_1.001 - 1bit] - 0-Off;1-On

- If set to **"no"** the objects will not be shown.
- If set to **"yes"** the *Status_Inx* object(s) and new parameters will appear.

4.9.2 Contact type

This parameter lets choose the behavior that will have the binary input depending on if the contact is normally open or normally closed.

- There are two possible options to configure the contact type: **"NO: Normally Open"** and **"NC: Normally Closed"**.

4.9.3 Debounce time

This parameter lets choose a debounce time (in milliseconds) that will be applied to the contact.

4.9.4 Disabling function

This parameter shows/hides the *Control_Disable Input x* communication object which will let disable/enable the input x.

- ↕ 50 Control_Disable Input 1 [DPT_1.003 - 1bit] - 0-Disable;1-Enable;
- ↕ 50 Control_Disable Input 1 [DPT_1.002 - 1bit] - 0-False;1-True

- If set to **"no"** any object will be shown.
- When **"DPT 1.003: 0-Disable; 1-Enable"** is selected, the input can be disabled using the value **"0"** and enabled using the value **"1"**.
- When **"DPT 1.002: 1-True (Disable); 0-False (Enable)"** is selected, the input can be disabled using the value **"1"** and enabled using the value **"0"**.

4.9.5 Function

This parameter lets choose the function that will have the binary input. There are 7 different functions available: Switching, Dimming, Shutter/Blind, Value, Execute Scene (internal), Occupancy (internal) and Window Contact (internal).

- When **"Switching"** is selected the communication object and new parameters for the Input "x" will appear as shown below.

■ ↕ 89 Status_In1 - Switching [DPT_1.001 - 1bit] - 0-Off;1-On

> Function	Switching
> Send telegram after bus recovery	No action
> Value on raising edge (contact activated)	Toggle (On/Off)
> Value on falling edge (contact deactivated)	No action
> Cyclical sending	Never

Figure 4.38 Parameter detail

➤ Send telegram after bus recovery

This parameter lets select if the Binary Input "x" will send a telegram, or not, after a bus recovery and the type of telegram sent (if enabled).

- When **"No action"** is selected, no telegram will be sent after a bus recovery.
- When **"Current status"** is selected, the binary input will send a telegram with its current status after a bus recovery. Also a new parameter will appear (see below).

- When **"On"** is selected, the binary input will send a telegram with a **"1"** value after a bus recovery. Also a new parameter will appear (see below).
- When **"Off"** is selected, the binary input will send a telegram with a **"0"** value after a bus recovery. Also a new parameter will appear (see below).

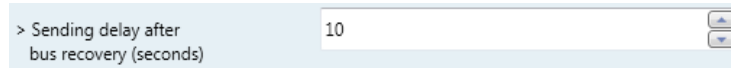

Figure 4.39 Parameter detail

➤ Sending delay after a bus recovery (seconds)

This parameter lets configure a delay (in seconds) that will be applied after a bus recovery and, after which, a telegram will be sent.

➤ Value on rising edge

This parameter lets select the value that the Binary Input "x" will send on a rising edge (contact activated).

- When **"On"** is selected, the binary input will always send telegrams with a **"1"** value.
- When **"Off"** is selected, the binary input will always send telegrams with a **"0"** value.
- When **"Toggle (On/Off)"** is selected, the binary input will send a **"1"** value after a **"0"** value and viceversa.
- When **"No action"** is selected, the binary input will not perform any action.

➤ Value on falling edge

This parameter lets select the value that the Binary Input "x" will send on a falling edge (contact deactivated).

- When **"On"** is selected, the binary input will always send telegrams with a **"1"** value.
- When **"Off"** is selected, the binary input will always send telegrams with a **"0"** value.
- When **"Toggle (On/Off)"** is selected, the binary input will send a **"1"** value after a **"0"** value and viceversa.
- When **"No action"** is selected, the binary input will not perform any action.

➤ Cyclical sending

This parameter lets enable/disable cyclical sending when a determined condition is met.

- When **"When output value is On"** is selected, everytime a **"1"** value is sent, it will be sent cyclically. Also a new parameter will appear (see below).
- When **"When output value is Off"** is selected, everytime a **"0"** value is sent, it will be sent cyclically. Also a new parameter will appear (see below).
- When **"Always"** is selected, the binary input will send any value cyclically. Also a new parameter will appear (see below).
- When **"Never"** is selected, cyclical sending will be disabled.

➤ Period for cyclical sending (seconds)

This parameter lets configure a time (in seconds) for the cyclical sending.

Figure 4.40 Parameter detail

- When **"Dimming"** is selected the communication objects and new parameters for the Input "x" will appear as shown below.

- 92 Status_In2 - Dimming - On/Off [DPT_1.001 - 1bit] - 0-Off;1-On
- 93 Status_In2 - Dimming - Step(%) [DPT_3.007 - 4bit] - Dimming step

Figure 4.41 Parameter detail

➤ Send telegram after bus recovery

This parameter lets select if the Binary Input "x" will send a telegram, or not, after a bus recovery and the type of telegram sent (if enabled).

- When **"No action"** is selected, no telegram will be sent after a bus recovery.
- When **"On"** is selected, the binary input will send a telegram with a **"1"** value after a bus recovery. Also a new parameter will appear (see below).

- When **"Off"** is selected, the binary input will send a telegram with a **"0"** value after a bus recovery. Also a new parameter will appear (see below).

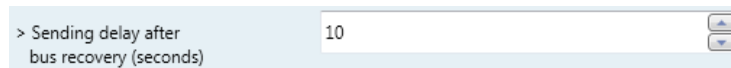

Figure 4.42 Parameter detail

➤ Sending delay after a bus recovery (seconds)

This parameter lets configure a delay (in seconds) that will be applied after a bus recovery and, after which, a telegram will be sent.

➤ Mode for short (long) operation

This parameter lets select the value that the Binary Input "x" will send on a rising edge (contact activated), for a short and a long operation.

- When **"On (increase)"** is selected, the binary input will always send telegrams with a **"1"** value for a short operation, and an **"increase step"** for a long operation.
- When **"Off (decrease)"** is selected, the binary input will always send telegrams with a **"0"** value for a short operation, and an **"decrease step"** for a long operation.
- When **"Toggle: On/Off (increase/decrease)"** is selected:
 - For the short operation the binary input will send a **"1"** value after a **"0"** value and viceversa.
 - For the long operation the binary input will send an **"increase step"** after a **"decrease step"** and viceversa.

⚠ **Important:** Note that the first long operation in toggle depends on the last short operation, meaning that after a **"1"** value will be sent a **"decrease step"** and after a **"0"** value will be sent an **"increase step"**.

⚠ **Important:** The time period between a short and a long operation is defined in the parameter "Short/long operation limit (x100ms)".

➤ Increasing step

This parameter lets select the increasing step value (in %) that will be sent for a long operation.

➤ Decreasing step

This parameter lets select the decreasing step value (in %) that will be sent for a long operation.

➤ Short/long operation limit (x100ms)

This parameter lets introduce the time period difference for the short and the long operation.

➤ Cycl. send. period in long oper. (x100ms)

This parameter lets configure a time (in seconds) for the cyclical sending of a long operation.

- When **"Shutter/Blind"** is selected the communication objects and new parameters for the Input "x" will appear as shown below.

- 94 Status_In3 - Shut/Blind - Step [DPT_1.023 - 1bit] - 0-Step Up;1-Step Down
- 95 Status_In3 - Shut/Blind - Move [DPT_1.023 - 1bit] - 0-Move Up;1-Move Down

> Function	Shutter/Blind
> Send telegram after bus recovery	No action
> Operation	Toggle (Up/Down)
> Method	Step-Move-Step
> Short/long operation limit (x100ms)	10
> Vanes adjustment time (x100ms)	10

Figure 4.43 Parameter detail

➤ Send telegram after bus recovery

This parameter lets select if the Binary Input "x" will send a telegram, or not, after a bus recovery and the type of telegram sent (if enabled).

- When **"No action"** is selected, no telegram will be sent after a bus recovery.
- When **"Move Up"** is selected, the binary input will send a telegram with a **"0"** value after a bus recovery. Also a new parameter will appear (see below).
- When **"Move Down"** is selected, the binary input will send a telegram with a **"1"** value after a bus recovery. Also a new parameter will appear (see below).

> Sending delay after bus recovery (seconds)	10
--	----

Figure 4.44 Parameter detail

➤ Sending delay after a bus recovery (seconds)

This parameter lets configure a delay (in seconds) that will be applied after a bus recovery and, after which, a telegram will be sent.

➤ Operation

This parameter lets select the value that the Binary Input "x" will send on a rising edge (contact activated).

- When "**Up**" is selected, the binary input will always send telegrams with a "**0**".
- When "**Down**" is selected, the binary input will always send telegrams with a "**1**" value.
- When "**Toggle (Up/Down)**" is selected the binary input will send a "**0**" value after a "**1**" value and viceversa.

➤ Method

This parameter lets select the working method for the shutter/blind.

- When "**Step-Move-Step**" is selected: On a rising edge (contact activated) a step/stop telegram will be sent and will begin a time called **T1**. If a falling edge occurs (contact deactivated) during the **T1**, no action will be performed.

If the rising edge is maintained longer than **T1**, a move telegram will be sent and will start a time called **T2**. If a falling edge occurs during the **T2**, a step/stop telegram will be sent. If a falling edge occurs after **T2** no action will be performed.

- When "**Move-Step**" is selected: On a rising edge a move telegram will be sent and will begin the **T2** time. If a falling edge occurs during the **T2**, a step/stop telegram will be sent. If a falling edge occurs after **T2** no action will be performed.

⚠ **Important:** The **T1** time have to be defined in the "Short/long operation limit (x100ms)" parameter. Also the **T2** time have to be defined in the "Vanes adjustment time (x100ms)" parameter.

➤ Short/long operation limit (x100ms)

This parameter lets introduce the time period difference for the short and the long operation (T1 time).

➤ Vanes adjustment time (x100ms)

This parameter lets introduce the time period for the vanes adjustment/blind movement (T2 time).

- When "**Value**" is selected the communication objects and new parameters for the Input "x" will appear as shown below.

➤ 97 Status_In4 - Value [DPT_5.010 - 1byte] - 1-byte unsigned value

> Function	Value
> Send telegram after bus recovery	Fixed value
> Sending delay after bus recovery (seconds)	10
> DPT to be sent	DPT 5.010 (1byte)
> Value on raising edge (when contact activated)	234

Figure 4.45 Parameter detail

➤ Send telegram after bus recovery

This parameter lets select if the Binary Input "x" will send a telegram, or not, after a bus recovery and the type of telegram sent (if enabled).

- When **"No action"** is selected, no telegram will be sent after a bus recovery.
- When **"Fixed value"** is selected, the binary input will send a telegram with the same value configured in the "Value on rising edge" parameter. Also a new parameter will appear (see below).

> Sending delay after bus recovery (seconds)	10
--	----

Figure 4.46 Parameter detail

➤ Sending delay after a bus recovery (seconds)

This parameter lets configure a delay (in seconds) that will be applied after a bus recovery and, after which, a telegram will be sent.

➤ DPT to be sent

This parameter lets select the DPT type for the value that will be defined in the next parameter. This value will be sent on a rising edge (contact activated).

> DPT to be sent	DPT 12.001 (4byte)
------------------	--------------------

Figure 4.47 Parameter detail

➤ Value on rising edge (when contact activated)

This parameter lets define a value for the DTP type configured in the "DPT to be sent" parameter. This value will be sent on a rising edge (contact activated).

- When **"Execute Scene (internal)"** is selected, the binary input "x" will activate the scene defined in the next parameter, on a rising edge (contact activated).

> Function	Execute Scene (internal)
> Scene when contact is activated (needs to be defined)	Scene 1

Figure 4.48 Parameter detail

➤ Scene when contact is activated

This parameter lets choose the scene that will be activated on a rising edge. This scene **MUST** be defined in the "Scene Configuration" dialog as a preset.

- When "**Occupancy (internal)**" is selected, the binary input "x" will have the same behavior as configured in the parameter "Enable use of Occupancy function" inside the "Switch-Off Timeouts Configuration" dialog.

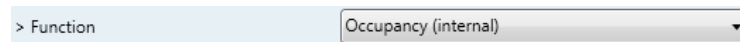
**Figure 4.49** Parameter detail

- When "**Window Contact (internal)**" is selected, the binary input "x" will have the same behavior as configured in the parameter "Enable use of Open Window / Switch off timeout function" inside the "Switch-Off Timeouts Configuration" dialog.

**Figure 4.50** Parameter detail

5. Specifications

Enclosure	ABS (UL 94 HB). 2,5 mm thickness
Dimensions	70 X 70 X 28 mm
Weight	70g
Color	Ivory white
Power supply	29V DC, 7mA Supplied through KNX bus.
Panasonic R1R2 Bus	Voltage: 13-15V Current: 10mA
LED indicators	1 x KNX programming.
Push buttons	1 x KNX programming.
Binary inputs	4 x Potential-free binary inputs. Signal cable length: 5m unshielded, may be extended up to 20m with twisted. Compliant with the following standards: IEC61000-4-2 : level 4 - 15kV (air discharge) - 8kV (contact discharge) MIL STD 883E-Method 3015-7 : class3B
Configuration	Configuration with ETS.
Operating Temperature	From -25°C to 60°C
Storage Temperature	From -40°C to 85°C
Isolation Voltage	2500V
RoHS conformity	Compliant with RoHS directive (2002/95/CE).
Certifications	CE conformity to EMC directive (2004/108/EC) and Low-voltage directive (2006/95/EC) EN 61000-6-1; EN 61000-6-3; EN 60950-1; EN 50491-3; EN 50090-2-2; EN 50428; EN 60669-1; EN 60669-2-1

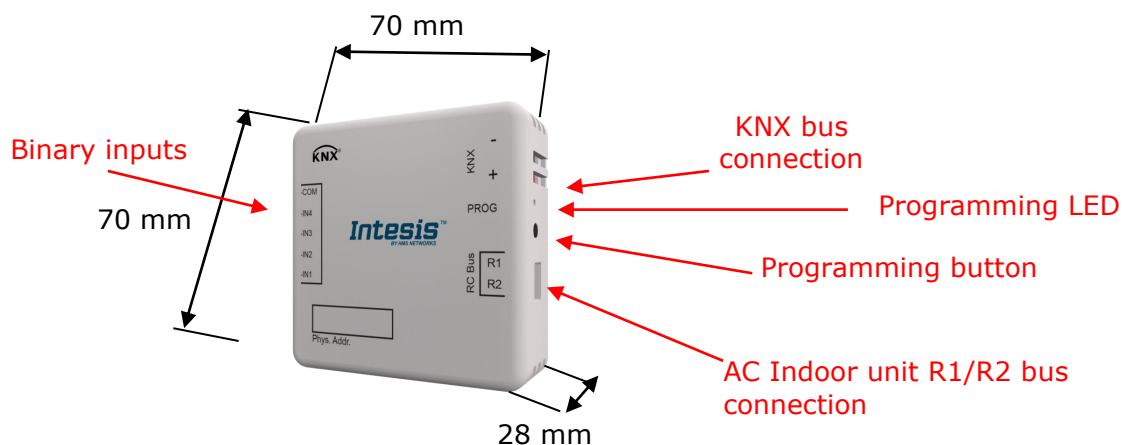

6. AC Unit Types compatibility

A list of Panasonic and Sanyo indoor unit model references compatible with INKNXPAN001R000 and their available features can be found in:

Panasonic:

https://www.intesis.com/docs/compatibilities/inxxxpan001rx00_compatibility

Sanyo:

https://www.intesis.com/docs/compatibilities/inxxxpan001rx00_sanyo_compatibility

7. Error Codes

Error Code	Error in Control Panel	Error category	Error Description
0	N/A	INKNXPAN001R000	No active error
01	A01	GHP Engine Issues	GHP - Engine oil pressure fault
02	A02		GHP - Engine oil level fault
03	A03		GHP - Engine over speed
04	A04		GHP - Engine under speed
05	A05		GHP - Ignition power supply failure
06	A06		GHP - Engine start up failure
07	A07		GHP - Fuel gas valve failure
08	A08		GHP - Engine stalled
09	A09		GHP - Engine overload
0A	A10		GHP - High exhaust gas temp
0B	A11		GHP - Engine oil level failure
0C	A12		GHP - Throttle actuator fault
0D	A13		GHP - Fuel gas valve adjustment failure
0E	A14		GHP - Engine oil pressure sensor fault
0F	A15		GHP - Starter power output short circuit
10	A16		GHP - Starter motor locked
11	A17		GHP - Starter current (CT) coil failed
13	A19		GHP - Wax Valve (3 Way) fault
14	A20		GHP - Cooling water temp high
15	A21		GHP - Cooling water level fault
16	A22		GHP - Cooling water pump fault
17	A23		GHP - Engine crank angle sensor failure
18	A24		GHP - Engine cam angle sensor failure
19	A25		GHP - Clutch fault
1A	A26		GHP - Misfire
1B	A27		GHP - Catalyst temperature fault
1C	A28		GHP - Generator fault
1D	A29		GHP - Converter fault
1E	A30		GHP - Fuel gas pressure low
21	C01		Central Controller Issues
22	C02	Central control number of units mis-matched	
23	C03	Incorrect wiring of central control	
24	C04	Incorrect connection of central control	
25	C05	System Controller fault, error in transmitting comms signal, i/door or o/door unit not working, wiring fault	
26	C06	System Controller fault, error in receiving comms signal, i/door or o/door unit not working, wiring fault, CN1 not connected correctly	
2C	C12	Batch alarm by local controller	
30	C16	Transmission error from adaptor to unit	
31	C17	Reception error to adaptor from unit	
32	C18	Duplicate central address in adaptor	
33	C19	Duplicate adaptor address	
34	C20	Mix of PAC & GHP type units on adaptor	
35	C21	Memory fault in adaptor	
36	C22	Incorrect address setting in adaptor	

37	C23		Host terminal software failure
38	C24		Host terminal hardware failure
39	C25		Host terminal processing failure
3A	C26		Host terminal communication failure
3C	C28		Reception error of S-DDC from host terminal
3D	C29		Initialization failure of S-DDC
3F	C31		Configuration change detected by adaptor
41	E01	Addressing and Communication Problems	Remote control detecting error from indoor unit, Address not set/Auto address failed. Check interconnecting wiring etc. Re-address system.
42	E02		Remote detecting error from indoor unit,
43	E03		Indoor unit detecting error from remote,
44	E04		Indoor seeing error from outdoor. Qty of i/d units connected are less than qty set. Check; all i/d units are ON, reset turn off all units wait 5min power up
45	E05		Indoor unit detecting error from outdoor unit, Error in sending comms signal
46	E06		Outdoor unit detecting error from indoor unit, Error in receiving comms signal
47	E07		Outdoor unit detecting error from indoor unit, Error in sending comms signal
48	E08		Incorrect setting indoor/controller, Indoor address duplicated
49	E09		Incorrect setting indoor/controller, Remote address duplicated or IR wireless controller not disabled
4A	E10		Indoor unit detecting error from 'option' plug, Error in sending comms signal
4B	E11		Indoor unit detecting error from 'option' plug, Error in receiving comms signal
4C	E12		Auto addressing failed, Auto address connector CN100 shorted during auto addressing
4D	E13		Indoor unit failed to send signal to remote controller
4E	E14		Setting Failure, Duplication of master indoor units
4F	E15		Auto addressing failed, Number of indoor units connected are less than number set
50	E16		Auto addressing failed, Number of indoor units connected are more than number set
51	E17		Group control wiring error, Main indoor unit not sending signal for sub indoor units
52	E18		Group control wiring error, Main indoor unit not receiving signal for sub indoor units
54	E20		Auto addressing failed, No indoor units connected
58	E24		Auto addressing failed, Error on sub outdoor unit
59	E25	Auto addressing failed, Error on outdoor unit address setting	
5A	E26	Auto addressing failed, Quantity of main and sub outdoor units do not correspond to the number set on main outdoor unit P.C.B.	
5D	E29	Auto addressing failed, Sub outdoor unit not receiving comms for main outdoor unit	
5F	E31	Between units, Comms failure with MDC, does E31 remain after power is re-instated? If so replace PCB. & power PCB	
61	F01	Sensor Faults	Indoor Heat Exch inlet temp sensor failure (E1)
62	F02		Indoor Heat Exch freeze temp sensor failure (E2)

63	F03		Indoor Heat Exch outlet temp sensor failure (E3)
64	F04		Outdoor Discharge temp sensor failure (TD) or (DISCH1)
65	F05		Outdoor Discharge temp sensor failure (DISCH2)
66	F06		Outdoor Heat Exch temp sensor failure (C1) or (EXG1)
67	F07		Outdoor Heat Exch temp sensor failure (C2) or (EXL1)
68	F08		Outdoor Air temp sensor failure (TO)
6A	F10		Indoor inlet temp sensor failure
6B	F11		Indoor outlet temp sensor failure
6C	F12		Outdoor Intake sensor failure (TS)
6D	F13		GHP - Cooling water temperature sensor failure
70	F16		Outdoor High pressure sensor failure
71	F17		GHP - Cooling water temperature sensor fault
72	F18		GHP - Exhaust gas temperature sensor fault
74	F20		GHP Clutch coil temperature fault
77	F23		Outdoor Heat Exch temp sensor failure (EXG2)
78	F24		Outdoor Heat Exch temp sensor failure (EXL2)
7D	F29		Indoor EEPROM error
7E	F30		Clock Function (RTC) fault
7F	F31		Outdoor EEPROM error
81	H01	Compressor Issues	Compressor Fault, Over current (Comp1)
82	H02		Compressor Fault, Locked rota current detected (Comp1)
83	H03		Compressor Fault, No current detected (Comp1)
85	H05		Compressor Fault, Discharge temp not detected (Comp1)
86	H06		Compressor Fault, Low Pressure trip
87	H07		Compressor Fault, Low oil level
88	H08		Compressor Fault, Oil sensor Fault (Comp1)
8B	H11		Compressor Fault, Over current (Comp2)
8C	H12		Compressor Fault, Locked rota current detected (Comp2)
8D	H13		Compressor Fault, No current detected (Comp2)
8F	H15		Compressor Fault, Discharge temp not detected (Comp2)
95	H21		Compressor Fault, Over current (Comp3)
96	H22		Compressor Fault, Locked rota current detected (Comp3)
97	H23		Compressor Fault, No current detected (Comp3)
99	H25		Compressor Fault, Discharge temp not detected (Comp3)
9B	H27		Compressor Fault, Oil sensor fault (Comp2)
9C	H28		Compressor Fault. Oil sensor (connection failure)
9F	H31		Compressor Fault. IPM trip (IMP current on temperature)
C1	L01	Incorrect Settings	Setting Error, Indoor unit group setting error
C2	L02		Setting Error, Indoor/outdoor unit type/model mismatched
C3	L03		Duplication of main indoor unit address in group control
C4	L04		Duplication of outdoor unit system address
C5	L05		2 or more controllers have been set as 'priority' in one system - shown on controllers set as 'priority'
C6	L06		2 or more controllers have been set as 'priority' in one

			system - shown on controllers not set as 'priority'
C7	L07		Group wiring connected on and individual indoor unit
C8	L08		Indoor unit address/group not set
C9	L09		Indoor unit capacity code not set
CA	L10		Outdoor unit capacity code not set
CB	L11		Group control wiring incorrect
CD	L13		Indoor unit type setting error, capacity
CF	L15		Indoor unit paring fault
D0	L16		Water heat exch unit setting failure
D1	L17		Miss-match of outdoor unit with different refrigerant
D2	L18		4-way valve failure
D3	L19		Water heat exch unit duplicated address
D5	L21		Gas type setup failure
E1	P01	Indoor Unit Problems	Indoor unit fault, Fan motor thermal overload
E2	P02		Outdoor unit fault, Compressor motor thermal overload, over or under voltage
E3	P03		Outdoor unit fault, Compressor discharge temperature too high (Comp1) over 111 °C. Low on ref gas, exp valve, pipework damage.
E4	P04		Outdoor unit fault, High pressure trip
E5	P05		Outdoor unit fault, Open phase on power supply. Check power on each phase, inverter pcb, control pcb
E9	P09		Indoor unit fault, Ceiling panel incorrectly wired
EA	P10		Indoor unit fault, Condensate float switch opened
EB	P11		GHP - Water Heat exch low temp (frost protection) fault
EC	P12		Indoor unit fault, Fan DC motor fault
EE	P14		Input from leak detector (If fitted)
EF	P15		Refrigerant loss, high discharge temp and EEV wide open and low compressor current draw.
F0	P16		Outdoor unit fault, Open phase on compressor power supply
F1	P17		Outdoor unit fault, Compressor discharge temperature too high (Comp2) over 111 degC. Low on ref gas, exp valve, pipework damage.
F2	P18		Outdoor unit fault, By-pass valve failure
F3	P19		Outdoor unit fault, 4 way valve failure, i/door temp rises in cooling or fills in heating. Check wiring, coil, pcb output, valve operation.
F4	P20		Ref gas, high temp/pressure fault, heat exch temp high C2, 55-60 degC, cooling over-load, sensor fault.
F6	P22		Outdoor unit fan motor fault, fan blade jammed, check connections, does fan turn freely, motor resistance 30-40ohm on each pair, no fan fault, yes pcb fault.
FA	P26		Outdoor unit fault, Compressor overcurrent - check winding resistance, Inverter failure - check internal resistance term HIC + & - to UVW 200-300Kohm or more
FC	P29		Outdoor unit fault, Inverter circuit fault - Motor-current Detection Circuit (MDC) fault, check comp windings, sensors C1 & TS, if ok possible pcb failure.
FD	P30		Indoor unit fault, System controller detected fault on sub indoor unit
FF	P31	Simultaneous operation multi control fault, Group	

			controller fault
65535 (-1)	N/A	INKNXPAN001R000	Error in the communication of INMBSPAN001R000 device with the AC unit

In case you detect an error code not listed, contact your nearest Panasonic or Sanyo technical support service.

8. Appendix A – Communication Objects Table

TOPIC	OBJECT NUMBER	NAME	LENGTH	DATAPOINT TYPE		FLAGS				FUNCTION
				DPT_NAME	DPT_ID	R	W	T	U	
On/Off	0	Control_ On/Off	1 bit	DPT_Switch	1.001		W	T		0 - Off; 1-On
Mode	1	Control_ Mode	1 byte	DPT_HVACContrMode	20.105		W	T		0 - Auto; 1 - Heat; 3 - Cool; 9 - Fan; 14 - Dry
	2	Control_ Mode Cool/Heat	1 bit	DPT_Heat/Cool	1.100		W	T		0 - Cool; 1 - Heat;
	3	Control_ Mode Cool & On	1 byte	DPT_Scaling	5.001		W	T		0% - Off; 0.1%-100% - On + Cool
	4	Control_ Mode Heat & On	1 byte	DPT_Scaling	5.001		W	T		0% - Off; 0.1%-100% - On + Heat
	5	Control_ Mode Auto	1 bit	DPT_Bool	1.002		W	T		1 - Auto
	6	Control_ Mode Heat	1 bit	DPT_Bool	1.002		W	T		1 - Heat
	7	Control_ Mode Cool	1 bit	DPT_Bool	1.002		W	T		1 - Cool
	8	Control_ Mode Fan	1 bit	DPT_Bool	1.002		W	T		1 - Fan
	9	Control_ Mode Dry	1 bit	DPT_Bool	1.002		W	T		1 - Dry
	10	Control_ Mode +/-	1 bit	DPT_Step	1.007		W			0 - Decrease; 1 - Increase
	Control_ Mode +/-	1 bit	DPT_UpDown	1.008		W			0 - Up; 1 - Down	
Fan Speed	11	Control_ Fan Speed / 3 Speeds	1 byte	DPT_Scaling	5.001		W	T		0%-49% - Speed 1; 50%-82% - Speed 2; 83%-100% - Speed 3;
		Control_ Fan Speed / 3 Speeds	1 byte	DPT_Enumerated	5.010		W	T		1 - Speed 1; 2 - Speed 2; 3 Speed 3;
	12	Control_ Fan Speed Man/Auto	1 bit	DPT_Bool	1.002		W	T		0 – Manual; 1 - Auto
	13	Control_ Fan Speed 1	1 bit	DPT_Bool	1.002		W	T		1 – Set Fan Speed 1
	14	Control_ Fan Speed 2	1 bit	DPT_Bool	1.002		W	T		1 – Set Fan Speed 2
15	Control_ Fan Speed 3	1 bit	DPT_Bool	1.002		W	T		1 – Set Fan Speed 3	

Fan Speed	16	Control_ Fan Speed +/-	1 bit	DPT_Step	1.007	W		0 - Decrease; 1 - Increase
		Control_ Fan Speed +/-	1 bit	DPT_UpDown	1.008	W		0 - Up; 1 - Down
Vanes Up-Down	17	Control_ Vanes U-D / 5 Pos	1 byte	DPT_Scaling	5.001	W	T	0%-29% - Pos1; 30%-49% - Pos2; 50%-69% Pos3; 70%-89% - Pos4; 90%-100% - Pos5
		Control_ Vanes U-D / 5 Pos	1 byte	DPT_Enumerated	5.010	W	T	1 - Pos1; 2 - Pos2; 3 - Pos3; 4 - Pos4; 5 - Pos5
	18	Control_ Vanes U-D Standby	1 bit	DPT_Bool	1.002	W	T	0 - Off; 1 - Standby
	19	Control_ Vanes U-D Pos1	1 bit	DPT_Bool	1.002	W	T	1 - Set Position 1
	20	Control_ Vanes U-D Pos2	1 bit	DPT_Bool	1.002	W	T	1 - Set Position 2
	21	Control_ Vanes U-D Pos3	1 bit	DPT_Bool	1.002	W	T	1 - Set Position 3
	22	Control_ Vanes U-D Pos4	1 bit	DPT_Bool	1.002	W	T	1 - Set Position 4
	23	Control_ Vanes U-D Pos5	1 bit	DPT_Bool	1.002	W	T	1 - Set Position 5
	25	Control_ Vanes U-D +/-	1 bit	DPT_Step	1.007	W		0 - Decrease; 1 - Increase
		Control_ Vanes U-D +/-	1 bit	DPT_UpDown	1.008	W		0 - Up; 1 - Down
Temperature	26	Control_ Setpoint Temperature	2 byte	DPT_Value_Temp	9.001	W	T	(°C)
	27	Control_ Setpoint Temp +/-	1 bit	DPT_Step	1.007	W		0 - Decrease; 1 - Increase
		Control_ Setpoint Temp +/-	1 bit	DPT_UpDown	1.008	W		0 - Up; 1 - Down
28	Control_ Ambient Temperature	2 byte	DPT_Value_Temp	9.001	W	T	(°C)	
Filter	29	Control_ Reset Filter	1 bit	DPT_Bool	1.015	W	T	1 - Reset filter
Timeout	30	Control_ Window Contact Status	1 bit	DPT_OpenClose	1.009	W	T	0 - Open; 1 - Closed
		Control_ Switch Off Timeout	1 bit	DPT_Start	1.010	W	T	0 - Stop; 1 - Start
	31	Control_ Occupancy	1 bit	DPT_Occupancy	1.018	W	T	0 - Not Occupied; 1 - Occupied

Locking	32	Control_ Sleep Timeout	1 bit	DPT_Start	1.010	W	T	0 - Stop; 1 - Start
	33	Control_ Lock Remote Control	1 bit	DPT_Bool	1.002	W	T	0 - Unlocked; 1 - Locked
	34	Control_ Lock Control Objects	1 bit	DPT_Bool	1.002	W	T	0 - Unlocked; 1 - Locked
Special Modes	35	Control_ Power Mode	1 bit	DPT_Start	1.010	W	T	0 - Stop; 1 - Start
	36	Control_ Econo Mode	1 bit	DPT_Start	1.010	W	T	0 - Stop; 1 - Start
	37	Control_ Additional Heat	1 bit	DPT_Start	1.010	W	T	0 - Stop; 1 - Start
	38	Control_ Additional Cool	1 bit	DPT_Start	1.010	W	T	0 - Stop; 1 - Start
Scenes	39	Control_ Save/Exec Scene	1 byte	DPT_SceneControl	18.001	W	T	0 to 4 - Exec. Scene 1 to 5; 128 to 132 - Save Scene 1 to 5
	40	Control_ Store Scene1	1 bit	DPT_Bool	1.002	W		1 - Store Scene
	41	Control_ Store Scene2	1 bit	DPT_Bool	1.002	W		1 - Store Scene
	42	Control_ Store Scene3	1 bit	DPT_Bool	1.002	W		1 - Store Scene
	43	Control_ Store Scene4	1 bit	DPT_Bool	1.002	W		1 - Store Scene
	44	Control_ Store Scene5	1 bit	DPT_Bool	1.002	W		1 - Store Scene
	45	Control_ Execute Scene1	1 bit	DPT_Bool	1.002	W	T	1 - Execute Scene
	46	Control_ Execute Scene2	1 bit	DPT_Bool	1.002	W	T	1 - Execute Scene
	47	Control_ Execute Scene3	1 bit	DPT_Bool	1.002	W	T	1 - Execute Scene
	48	Control_ Execute Scene4	1 bit	DPT_Bool	1.002	W	T	1 - Execute Scene
	49	Control_ Execute Scene5	1 bit	DPT_Bool	1.002	W	T	1 - Execute Scene
Disabling	50	Control_ Disable Input 1	1 bit	DPT_Bool	1.002	W	T	0 - False; 1 - True
		Control_ Disable Input 1	1 bit	DPT_Enable	1.003	W	T	0 - Disable; 1 - Enable
	51	Control_ Disable Input 2	1 bit	DPT_Bool	1.002	W	T	0 - False; 1 - True
		Control_ Disable Input 2	1 bit	DPT_Enable	1.003	W	T	0 - Disable; 1 - Enable

	52	Control_Disable Input 3	1 bit	DPT_Bool	1.002		W	T	0 - False; 1 - True
		Control_Disable Input 3	1 bit	DPT_Enable	1.003		W	T	0 - Disable; 1 - Enable
	53	Control_Disable Input 4	1 bit	DPT_Bool	1.002		W	T	0 - False; 1 - True
		Control_Disable Input 4	1 bit	DPT_Enable	1.003		W	T	0 - Disable; 1 - Enable
On/Off	54	Status_On/Off	1 bit	DPT_Switch	1.001	R		T	0 - Off; 1-On
Mode	55	Status_Mode	1 byte	DPT_HVACContrMode	20.105	R		T	0 - Auto; 1 - Heat; 3 - Cool; 9 - Fan; 14 - Dry
	56	Status_Mode Cool/Heat	1 bit	DPT_Heat/Cool	1.100	R		T	0 - Cool; 1 - Heat
	57	Status_Mode Auto	1 bit	DPT_Bool	1.002	R		T	1 - Auto
	58	Status_Mode Heat	1 bit	DPT_Bool	1.002	R		T	1 - Heat
	59	Status_Mode Cool	1 bit	DPT_Bool	1.002	R		T	1 - Cool
	60	Status_Mode Fan	1 bit	DPT_Bool	1.002	R		T	1 - Fan
	61	Status_Mode Dry	1 bit	DPT_Bool	1.002	R		T	1 - Dry
	62	Status_Mode Text	14 byte	DPT_String_8859_1	16.001	R		T	ASCII String
Fan Speed	63	Status_Fan Speed / 3 Speeds	1 byte	DPT_Scaling	5.001		W	T	33% - Speed 1; 67% - Speed 2; 100% - Speed 3;
		Status_Fan Speed / 3 Speeds	1 byte	DPT_Enumerated	5.010		W	T	1 - Speed 1; 2 - Speed 2; 3 Speed 3;
	64	Status_Fan Speed Manual/Auto	1 bit	DPT_Bool	1.002	R		T	0 – Manual; 1 - Auto
	65	Status_Fan Speed 1	1 bit	DPT_Bool	1.002	R		T	1 – Fan is in speed 1
	66	Status_Fan Speed 2	1 bit	DPT_Bool	1.002	R		T	1 – Fan is in speed 2
	67	Status_Fan Speed 3	1 bit	DPT_Bool	1.002	R		T	1 - Fan is in Speed 3
	68	Status_Fan Speed Text	14 byte	DPT_String_8859_1	16.001	R		T	ASCII String
Vanes Up-Down	69	Status_Vanes U-D / 5 Pos	1 byte	DPT_Scaling	5.001	R		T	20% - Pos1; 40% - Pos2; 60% - Pos3; 80% - Pos4; 100% - Pos5
		Status_Vanes U-D / 5 Pos	1 byte	DPT_Enumerated	5.010	R		T	1 - Pos1; 2 - Pos2; 3 - Pos3; 4 - Pos4; 5 – Pos5

	70	Status_ Vanes U-D Standby	1 bit	DPT_Bool	1.002		W	T	0 – Off; 1 - Standby
	71	Status_ Vanes U-D Pos1	1 bit	DPT_Bool	1.002	R		T	1 - Position 1
	72	Status_ Vanes U-D Pos2	1 bit	DPT_Bool	1.002	R		T	1 - Position 2
	73	Status_ Vanes U-D Pos3	1 bit	DPT_Bool	1.002	R		T	1 - Position 3
	74	Status_ Vanes U-D Pos4	1 bit	DPT_Bool	1.002	R		T	1 - Position 4
	75	Status_ Vanes U-D Pos5	1 bit	DPT_Bool	1.002	R		T	1 - Position 5
	76	Status_ Vanes U-D Swing	1 bit	DPT_Bool	1.002	R		T	0 – Off; 1 - Swing
	77	Status_ Vanes U-D Text	14 byte	DPT_String_8859_1	16.001	R		T	ASCII String
Temperature	78	Status_ AC Setpoint Temp	2 byte	DPT_Value_Temp	9.001	R		T	(°C)
	79	Status_ AC Return Temp	2 byte	DPT_Value_Temp	9.001	R		T	(°C)
Filter	80	Status_ Filter Status	1 bit	DPT_Bool	1.002	R		T	0 - No Alarm; 1 - Alarm
Error	81	Status_ Error/Alarm	1 bit	DPT_Alarm	1.005	R		T	0 - No Alarm; 1 - Alarm
	82	Status_ Error Code	2 byte	Enumerated		R		T	0 - No Error; Any other see user's manual
	83	Status_ Error Text code	14 byte	DPT_String_8859_1	16.001	R		T	3 char PA Error; Empty - none
Special Modes	84	Status_ Power Mode	1 bit	DPT_Switch	1.001	R		T	0 - Off; 1-On
	85	Status_ Econo Mode	1 bit	DPT_Switch	1.001	R		T	0 - Off; 1-On
	86	Status_ Additional Heat	1 bit	DPT_Switch	1.001	R		T	0 - Off; 1-On
	87	Status_ Additional Cool	1 bit	DPT_Switch	1.001	R		T	0 - Off; 1-On
Counter	88	Status_ Operation Hour Counter	2 byte	DPT_Value_2_Ucount	7.001	R		T	Number of operating hours
Scene	89	Status_ Current Scene	1 byte	DPT_SceneNumber	17.001	R		T	0 to 4 - Scene 1 to 5; 63 - No Scene
Binary Inputs	90	Status_ Inx - Switching	1 bit	DPT_Switch	1.001	R		T	0 - Off; 1-On
	92	Status_ Inx – Dimming - On/Off	1 bit	DPT_Switch	1.001	R		T	0 - Off; 1 - On
	94								

	96	Status_ Inx – Shut/Blind - Step	1 bit	DPT_ShutterBlinds	1.023	R		T	0 – Step Up; 1 – Step Down
	91	Status_ Inx – Value	1 byte	DPT_Value_1_Ucount	5.010	R		T	1 byte unsigned value
		Status_ Inx – Value	2 byte	DPT_Value_2_Ucount	7.001	R		T	2 byte unsigned value
		Status_ Inx – Value	2 byte	DPT_Value_2_Count	8.001	R		T	2 byte signed value
		Status_ Inx – Value	2 byte	DPT_Value_Temp	9.001	R		T	Temperature (°C)
		Status_ Inx – Value	4 byte	DPT_Value_4_Ucount	12.001	R		T	4 byte unsigned value
		Status_ Inx – Dimming – Step(%)	1 bit	DPT_Control_Dimm.	3.007	R		T	Dimming step
		Status_ Inx - Shut/Blind -Move	1 bit	DPT_ShutterBlinds	1.023	R		T	0 – Move Up; 1 – Move Down