

**Transponder Holder  
TH22A01KNX  
TH22A11KNX**

***Product Handbook***



Product: **Transponder Holder**

Order Code: **TH22A01KNX - TH22A11KNX**

Application Program ETS: **EEL\_HDT1\_10 Transponder Card Holder**

## Index

		<b>Pag.</b>
<b>1</b>	<b>General Introduction</b> .....	<b>3</b>
<b>2.</b>	<b>Technical data</b> .....	<b>4</b>
<b>2.1</b>	<b>Wiring Diagram</b> .....	<b>5</b>
<b>2.2</b>	<b>Operating and display elements</b> .....	<b>5</b>
<b>2.3</b>	<b>Dimension drawing</b> .....	<b>5</b>
<b>2.4</b>	<b>Mounting and wiring hints</b> .....	<b>6</b>
<b>3.</b>	<b>Product and functional overview</b> .....	<b>7</b>
<b>4.</b>	<b>Parameters</b> .....	<b>9</b>
<b>4.1</b>	<b>Parameter window “General Configurations”</b> .....	<b>9</b>
<b>4.2</b>	<b>Parameter Window “Relay 1 Configuration”</b> .....	<b>12</b>
<b>4.3</b>	<b>Parameter Window “Relay 2 Configuration”</b> .....	<b>14</b>
<b>4.4</b>	<b>Parameter Window “Input 1 Configuration”</b> .....	<b>15</b>
<b>5</b>	<b>Communication Objects</b> .....	<b>18</b>
<b>6</b>	<b>Application Notes</b> .....	<b>22</b>

## 1 General Introduction

Eelectron is an Italian company with a focus on designing and manufacturing electronic devices dedicated to building and home evolution and closely related software tools.

As of year 2005, Eelectron applies to KNX association, fulfilling his requirements with the main goal of giving a contribution to the diffusion of the world's only open Standard for home and building automation.

Eelectron philosophy of comprehensive aesthetic design and engagement in developing highly innovative devices, matched with KNX Interoperability and compliance with international requirements, has engendered Eelectron's distinct reputation.

Eelectron experience is devoted to end users, with a constant training activity, assistance on products and a continuous development that deserves particular attention to upcoming needs and applications, to energy saving and to solutions directed to make Users life easier and simpler.

## 2. Technical data

### Transponder Holder



Order Code :  
TH22A01KNX (Light Grey Varnished)  
TH22A11KNX (Dark Grey)

The transponder holder TH22A01KNX is an EIB/KNX wall mounting device suitable to access and control detection of people inside a room as well as simple holder of user's transponder card.

The device is equipped with two binary inputs (potential free contacts) that can be used, for instance, to control whether the door lock has been opened or closed or other signals coming from external switches/contacts (i.e. windows, bathroom emergency alarms, etc..).

The transponder reader is equipped also with two output relays which can be used for any purposes, typically to open the door or turning on the courtesy light inside the room.

The Transponder Holder reads the card while inserting inside the slot.

The device configuration for commissioning in terms of physical address, group addresses and parameters is done with ETS ( Engineering Tool Software) through a download of the Application Program.

<b>Power Supply</b>	External Auxiliary Voltage	<ul style="list-style-type: none"> <li>• 12 (24) V AC/DC <math>\pm</math> 10%</li> </ul>
<b>Inputs</b>	Number Input Signal Voltage Input Signal Current (close contact)	<ul style="list-style-type: none"> <li>• 2 (potential free)</li> <li>• <math>U_n = 24V</math></li> <li>• <math>I_n = 1ma</math></li> </ul>
<b>Outputs relays</b>	Number Output switching currents	<ul style="list-style-type: none"> <li>• 2</li> <li>• 24 VAC, 2A cosp 0.6.</li> </ul>
<b>Control Elements</b>	1 programming push button	
<b>Display elements</b>	1 LED red (back) for ETS programming 1 LED blue for lighting slot	
<b>Physical specifications and Dimensions</b>	Housing Colours  Dimensions Weight Installation	<ul style="list-style-type: none"> <li>• plastic</li> <li>• Light Grey Varnished (TH22A01KNX), Dark Grey (TH22A11KNX)</li> <li>• (WxHxD): 110 x 78 x 37,1 mm</li> <li>• ca. 120 g.</li> <li>• flash mounting in 2-3 modules or wall round box <math>\varnothing</math>60mm, 40mm deep</li> </ul>
<b>Electrical Safety</b>	Pollution degree Protection class Safety class Overvoltage category	<ul style="list-style-type: none"> <li>• 2 (according to EN 60664-1)</li> <li>• IP20 (according to EN 60529)</li> <li>• III (according to EN 61140)</li> <li>• III (according to EN 60664-1)</li> </ul>
<b>CE Mark and Certifications</b>	CE  EIB/KNX	<ul style="list-style-type: none"> <li>• In accordance with EMC and Low Voltage guidelines</li> <li>• According to EN 50090-1-2</li> </ul>

## 2.1 Wiring Diagram

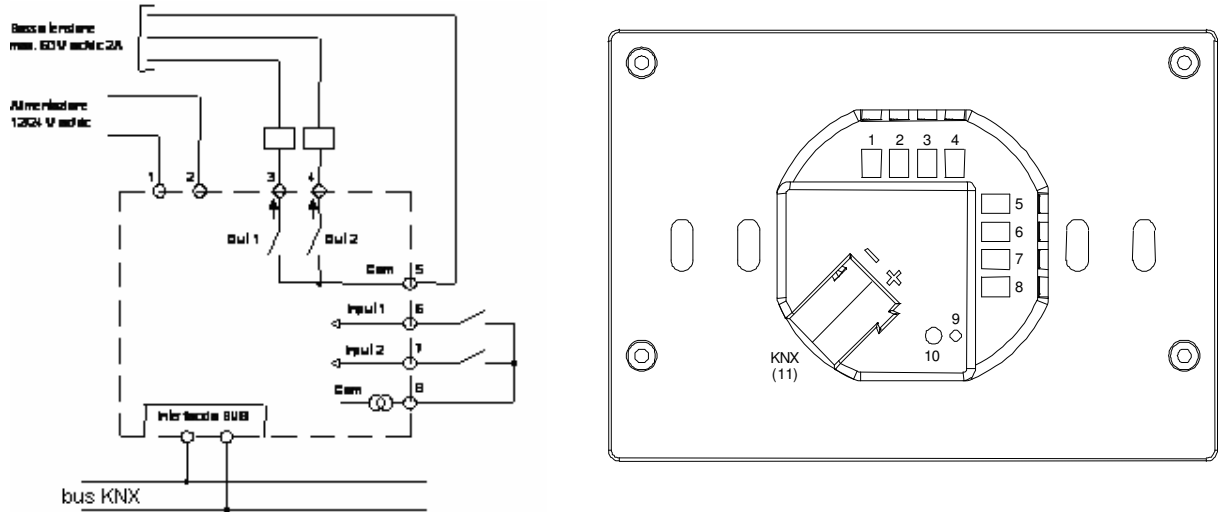

## 2.2 Operating and display elements

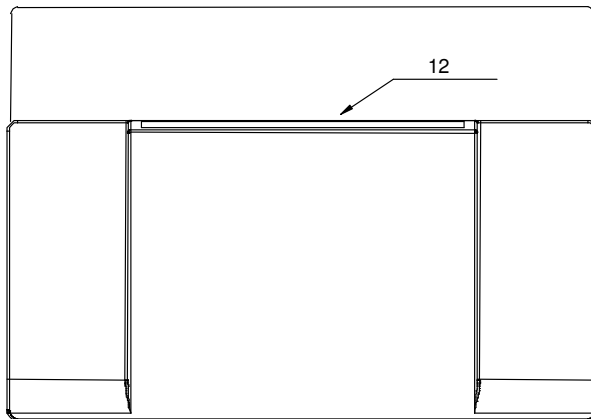

### Terminals:

- 1 Power Supply 12/24 Vcc/ac
- 2 Power Supply 12/24 Vcc/ac
- 3 OUT 1 terminal relay 1 (NO)
- 4 OUT 2 terminal relay2 (NO)
- 5 COM Outputs
- 6 IN 1 (potential free)
- 7 IN 2 (potential free)
- 8 COM Inputs
- 11 Bus Connection Terminal:  
 Black = bus polarity (-)  
 Red = bus polarity (+)

### Operating Elements:

- 9 Programming LED
- 10 Programming button
- 12 LED blue for card insertion slot lighting

## 2.3 Dimension drawing

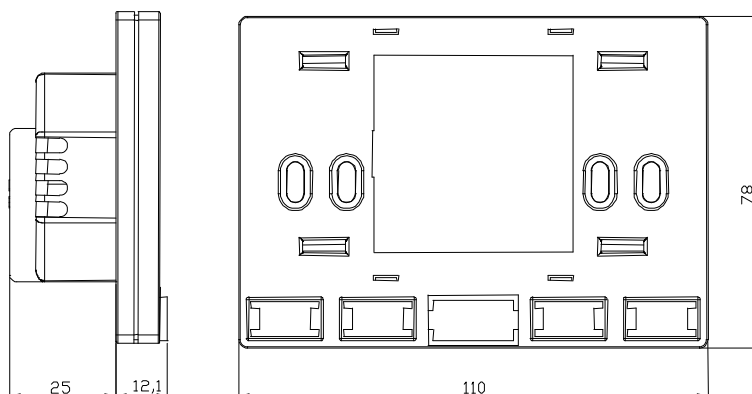

## 2.4 Mounting and wiring hints

The device may be used for permanent indoor installations in dry locations within wall boxes.

### Requirements for installation

- The device must not be connected to 230V cables.
- The prevailing safety rules must be heeded.
- The device must be mounted and commissioned by an authorised installer.
- The applicable safety and accident prevention regulations must be observed.
- The device must not be opened. Any faulty devices should be returned to manufacturer.
- For planning and construction of electric installations, the relevant guidelines, regulations and standards of the respective country are to be considered.

### Requirements for commissioning

- Connect each single KNX/EIB bus core inside the bus connection terminal block observing bus polarity .
- Slip the bus connection block into the guide slot placed on the front side of this device and press the block down to the stop.
- In order to commission the device, a PC with ETS2 version V1.3 or higher is required as well as an interface to the bus, e.g. via an RS232 interface or via a USB interface.
- The device configuration (KNX physical address assignment) is done by pressing the programming push button located on the front of the housing.

### Supplied state

- The device is supplied with the physical address 15.15.255.
- It is therefore necessary to load parameters and group addresses during commissioning. However the complete application program can be reloaded if required.
- The bus connection terminal block is included in the package.
- The instruction sheet is included in the package.

### Maintenance

- The device is maintenance free.
- In case of damage during transportation or storage, no repairs may be carried out by external staff.
- When the device is opened the right to claim under guarantee expires.

### 3. Product and functional overview

The **Transponder Holder TH22A01KNX/TH22A11KNX** is an EIB/KNX wall mounting device suitable to access and control detection of people entrance inside a room as well as simple holder of user's transponder card.

The device is equipped with two binary inputs (potential free contacts) that can be used, for instance, to control whether the door lock has been opened or closed or other signals coming from external switches/contacts (i.e. windows, bathroom emergency alarms, etc..). The transponder reader is equipped also with two output relays which can be used for any purposes, typically to open the door or turning on the courtesy light inside the room or as normal binary outputs controlled by their associated communication objects.

The front of transponder holder is illuminated when no card is present, turned off when card is accepted and flashes for 3 seconds when card is refused (entrance not allowed).

The Transponder Holder reads the card while inserting inside the slot.

The access control follows a checking sequence where the "build number" has been checked at first, then the expiration data, next the password ID for client/guest/service identification, then the enabled days of week and hours range. In case all information is acknowledged the Transponder Holder can open the door, switch ON the courtesy light and enable all room services and loads inside the room.

At the same time the Transponder Holder sends the access response to the bus in order to be detected and stored by a visualization or management software..

The device can identify 4 classes of users depending on password detection and to each of them a 1 bit object "Scenario" is available. As one user is identified and the access acknowledge the transponder holder sends the object "Scenario X" corresponding to the user class detected, so activating a scenario inside the room conforming to user profile.

In an Hotel application, for instance, these 4 categories can be used to identify clients, service staff, maintenance staff or emergency service.

As the transponder card is extracted from the holder (e.g. user exit) the current scenario is switched OFF and after a programmed timeout also the energy and lights inside the room can be switched OFF.

The energy and light enable commands as well as the "Scenario 1" (corresponding to client password category) can be activated simulating a client card insertion while receiving the 1 bit object "Enable Insert Card". This feature can be used for instance, in case of Hotel application, to enable all room services from the reception (i.e. from the Hotel management software) for testing or maintenance purposes or for any other needs.

This device provides also an alarm function by sending an "Alarm" object (1bit) to alarm, for instance, a centralized visualization software (e.g. "eAccess" or "eHotel") that a power failure was occurred and then recovered next. This advice can be useful to visualization and monitoring software to update some configuration data to the readers and to the card holders or for other purposes.

The physical address, group address and parameters are assigned and programmed with the ETS tool software. In order to commission the device, a PC with ETS2 version V1.3 or higher is required as well as an interface to the bus, e.g. via an RS232 interface or via a USB interface.

This device must be configured and loaded with the following application program:

**EEL\_HDT1\_10 Transponder Card Holder**

With this application program the following functions can be parametrized and configured:

Application Program: EEL HDT1 10 Transponder Card Holder

- Max number of group addresses: 35
- Max number of group address associations: 32

<b>General Configurations</b>	<ul style="list-style-type: none"> <li>• <i>Timeout for energy and lights switching OFF after transponder card extraction</i></li> <li>• <i>Holder light enable</i></li> <li>• <i>Grant date control enable</i></li> <li>• <i>Grant days control enable</i></li> <li>• <i>Grant hours control</i></li> <li>• <i>Power failure and recovery alarm enable</i></li> </ul>
<b>Input 1 (and 2) Configuration</b>	<ul style="list-style-type: none"> <li>• <i>Switching states ON or OFF can be set depending on input pulse edge evaluation (rising or falling edge).</i></li> <li>• <i>Cyclical sending option at adjustable intervals</i></li> </ul>
<b>Relay 1 Configuration</b>	<ul style="list-style-type: none"> <li>• <i>“General Purpose” or “Door Open/Courtesy Light” function selection</i></li> <li>• <i>Normally open or closed contact setting</i></li> <li>• <i>Time switching (e.g.: “Door lock timing release”)</i></li> </ul>
<b>Relay 2 Configuration</b>	<ul style="list-style-type: none"> <li>• <i>“General Purpose” or “Courtesy Light” function selection</i></li> <li>• <i>Normally open or closed contact setting</i></li> <li>• <i>Time switching (e.g.: “Courtesy light timeout”)</i></li> </ul>

Note: The default settings for the options are underlined (e.g. Options: no/yes)



## 4. Parameters

### 4.1 Parameter window “General Configurations”

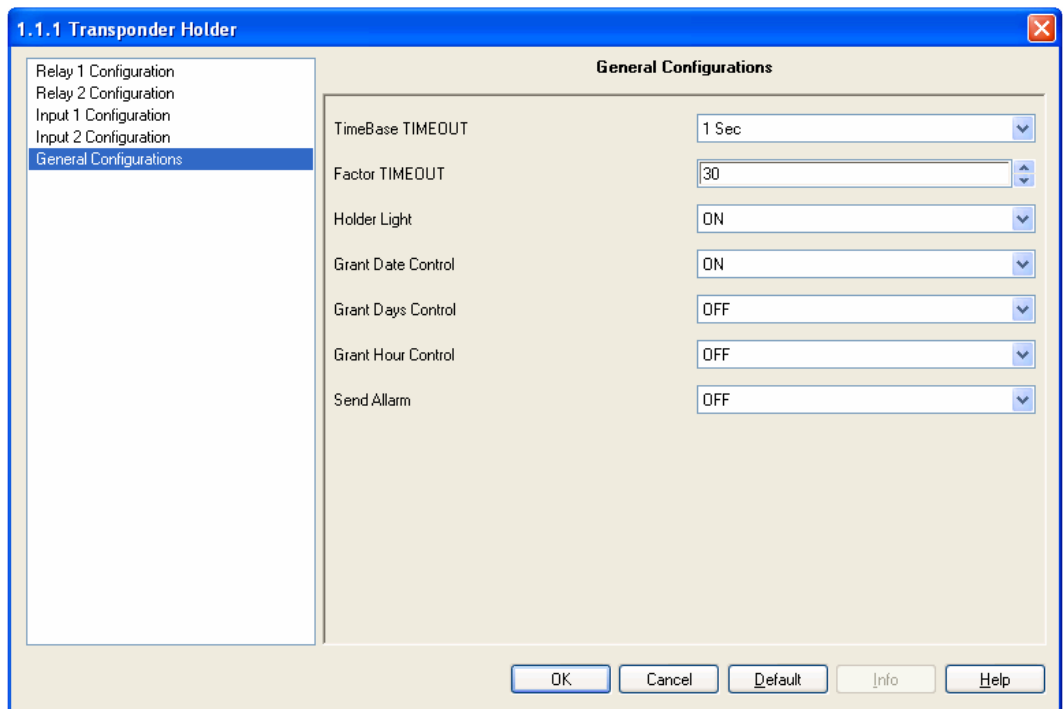

Fig. 1: Parameter Window “General Configurations”

- **TimeBase TIMEOUT**

This parameter and the next are used to set up a timeout for switching OFF energy, lighting and the current activated scenario inside the room when the card is extracted from the holder.

After the card extraction the timeout is started and at the end the objects “Energy Enabled”, “Room Light Enabled” and “Scenario X” active are sent with value “0” (OFF).

This timeout is calculated from the selected base “TimeBase TIMEOUT” multiplied by the factor “Factor TIMEOUT” that is entered here:

$$T_{\text{OFF}} = \text{TimeBase TIMEOUT} \times \text{Factor TIMEOUT}$$

Options: 250ms, 500ms, 1sec, 1min, 1ora

- **Factor TIMEOUT**

Options: 0...30...255

Note: An attempt should always be made to set the required time with the smallest possible base as the base that is selected here also simultaneously specifies the maximum timing error.

- **Holder Light**

Options:  $\frac{ON}{OFF}$

Option “ON”: enable the led (blue) to enlight the card insertion slot. This feature can be useful for device localization while dark. In this case the slot light is always ON when no card is inserted, OFF when a card is inserted and flash 3 seconds in case of card reading error or card not acknowledge.

Option “OFF”: the holder light is always OFF.  
The riding error or card not acknowledge signalling is maintained (flashing about 3 seconds)

- **Grant Date Control**

Options:  $\frac{ON}{OFF}$

Option “ON”: enables expiration date control during transponder card or key reading.

Option “OFF”: disables expiration date control

- **Grant Days Control**

Options:  $\frac{OFF}{ON}$

Option “OFF”: the days of week allowed for entrance are not checked.

Option “ON”: enables the days of week control.

- **Grant Hour Control**

Options:  $\frac{OFF}{ON}$

Option “OFF”: the permitted hours range is not checked during card reading. This information is normally transmitted together with the user password by a visualization or building management software (eg: software “eHotel” o “eAccess”) during commissioning and start up or, in case of Hotel management, during a client “check in”.

Option “ON”: enable hours range checking during transponder holder card reading.

- **Send Alarm**

Options:             $\frac{OFF}{ON}$

Option “*OFF*”: the device does not send the object “Alarm”

Option “*ON*”: the device sends the object “Alarm” in case of power failure after the power supply has been recovered.

Note: this feature is useful to visualization software in order to re-send data to the readers after a power failure in order to re-synchronize data and time with the central unit (pc) or for any other purposes.

## 4.2 Parameter Window “Relay 1 Configuration”

The Relay 1 configuration parameters are shown in the next window:

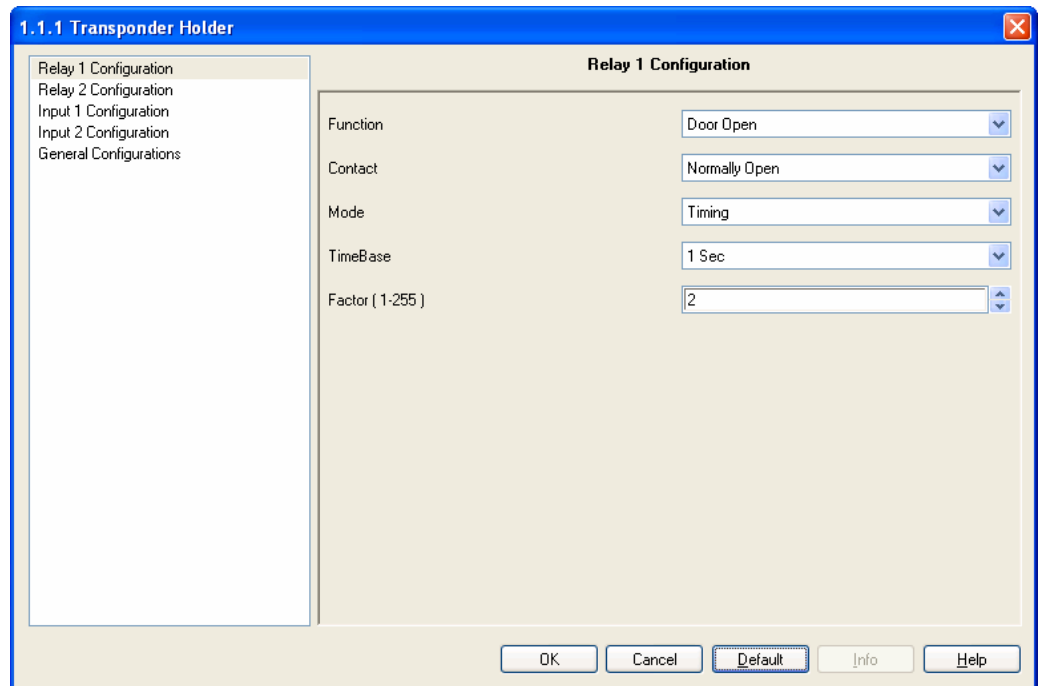

Fig. 2: Parameter Window “Relay1 Configuration”

### ▪ **Function**

Options:     *General Purpose*  
               *Door Open*

Option “*General Purpose*”: Relay 1 is controlled only by the “Relay 1” (1 bit) communication object as normal independent binary output channel.

Option “*Door Open*”: the Relay 1 is switched (ON or OFF depending on option selected in the next parameter “Contact”) if a valid transponder card is read or via the “Door/Courtesy Light” (1 bit) communication object.

With this option in case the relay 2 is configured with function “Courtesy Light” (see next) the 1 bit object “Door/Courtesy Light” controls both relays simultaneously (e.g. Relay 1 to open the door, Relay 2 to switch on the courtesy light inside the room).

### ▪ **Contact**

Options:     *Normally Open*  
               *Normally Close*

Option “*Normally Opened*”:  
     Off telegram = contact open  
     On telegram = contact closed.

- . Option "*Normally Closed*":  
     Off telegram = contact closed  
     On telegram = contact open.

- **Mode**

Option:        *Normal*  
                   *Timing*

Option "*Normal*": the Relay1 will be switched ON by sending an ON command and will be switched OFF by sending an OFF command within the associated object "Relay 1".

The status of the relay contact can be inverted by parameter setting "Contact": Normally Close".

Option "*Timing*": enable the time switch function (e.g. electrical lock control).

When an On telegram is received via the output object, it is routed directly to the relay. The Off delay that has been assigned starts at the same time. Every further "1" (ON) that is received before the timer has elapsed, resets the delay and restarts it. Once the period has elapsed, a "0" is passed to the output. An Off telegram deletes the Off delay and is immediately routed to the output.

The timeout is calculated from the selected base "TimeBase" multiplied by the factor "Factor" that is entered here:

$$T_{ON} = \text{TimeBase} \times \text{Factor}$$

Note: An attempt should always be made to set the required time with the smallest possible base as the base that is selected here also simultaneously specifies the maximum timing error.

- **TimeBase**

Options:        *250ms, 500ms, 1Sec, 1Min, 1Hour*

- **Factor (1-255)**

Options:        *0...2...255*

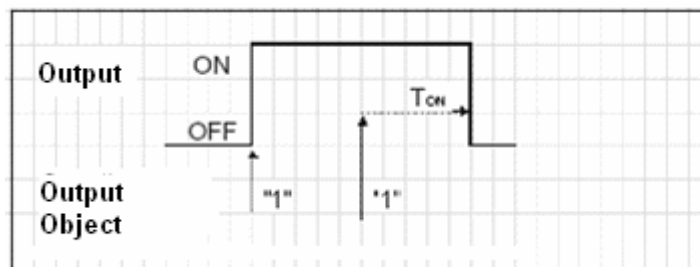

Fig. 3: Timing Mode (e.g. for electrical lock pulse operating control).

### 4.3 Parameter Window “Relay 2 Configuration”

Relay 2 differs from Relay 1 only for the first parameter setting “Function”.

The Relay 2 configuration parameters are shown in the next window:

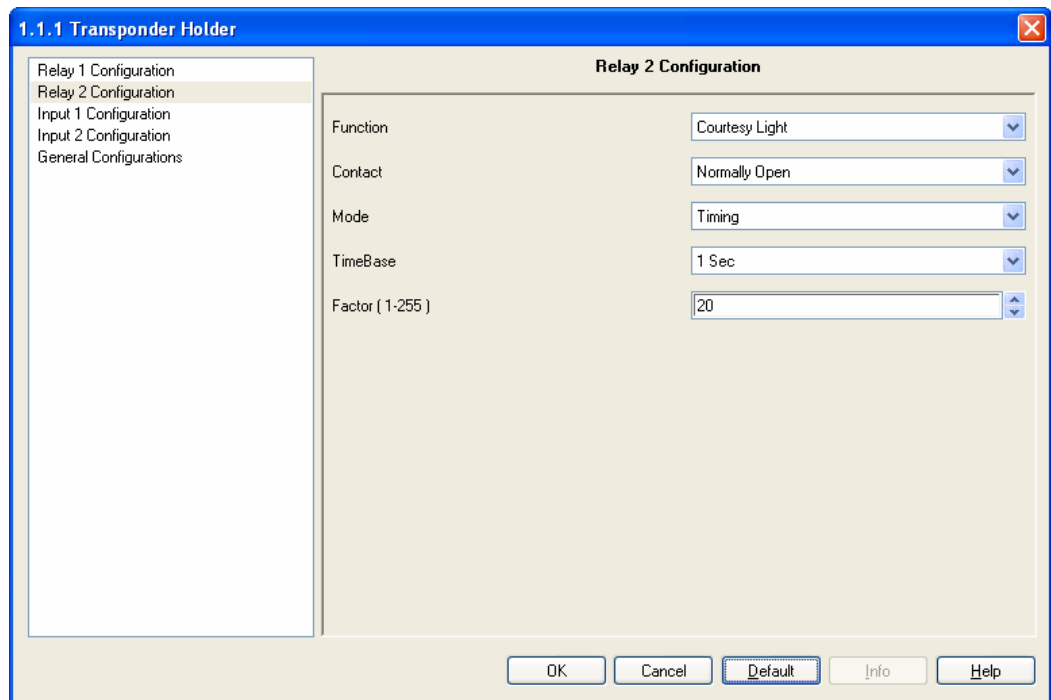

Fig. 4: Parameter Window “Relay 2 Configuration”

- **Function**

Opzioni:     *General Purpose*  
                   *Courtesy Light*

Option “*General Purpose*”: Relay 2 is controlled only by the “Relay 2” (1 bit) communication object as normal independent binary output channel.

Option “*Courtesy Light*”: the Relay 2 is switched (ON or OFF depending on option selected in the next parameter “Contact”) if a valid transponder card is read or via the “Courtesy Light” (1 bit) communication object or, in case the function “Door Open” has been assigned to Relay 1, with the “Door/Courtesy Light” 1 bit object.

**All the other parameters are completely similar to “Relay 1 Configuration” settings, so please see functional descriptions in par. 4.2.**

**Note:** please see *Outputs timing diagrams* in “Application Notes”.

## 4.4 Parameter Window “Input 1 Configuration”

Parameters associated to Input1 channel are the same as ones associated to Input 2.

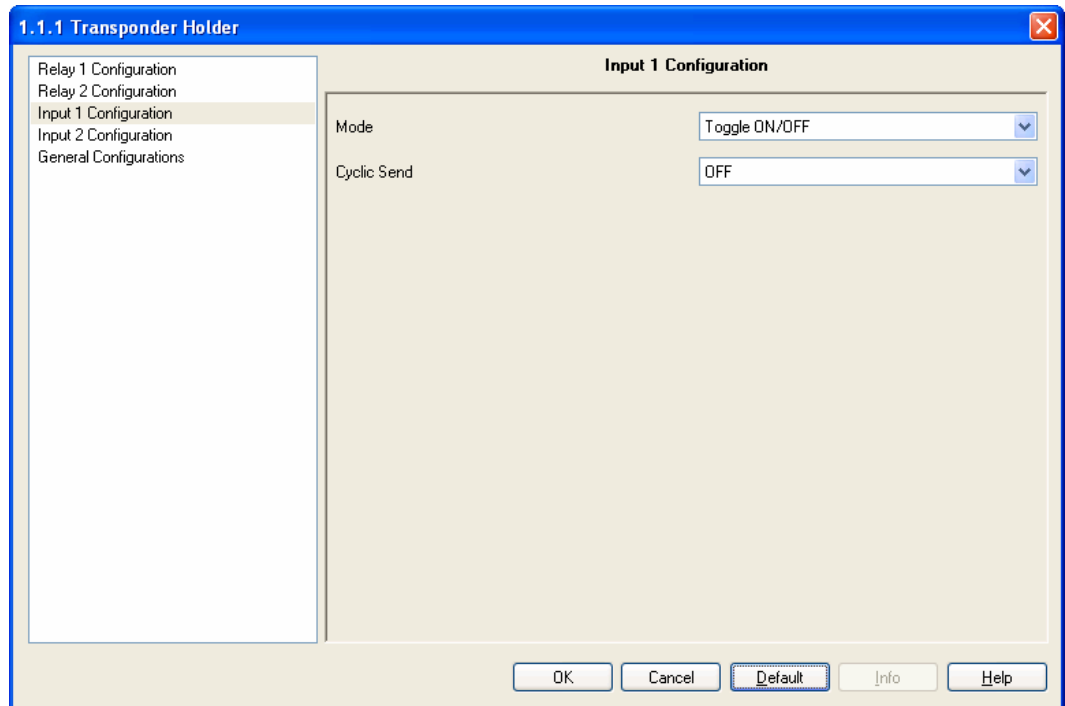

Fig. 5: Parameter Window “Input 1 Configuration”

### Mode

Options:

Rising ON  
Rising OFF  
Falling ON  
Falling OFF  
Rising ON / Falling OFF  
Rising OFF / Falling ON  
Toggle ON/OFF  
Toggle OFF/ON

With this parameter we can program which status we need to send to the bus (ON/OFF; TOGGLE) when a rising or falling edge is detected in the input signal.

### Behaviour:

“Rising On”: A rising edge causes a logic “1” to be transferred to the communication object. A falling edge does not alter the object value.

“Rising Off”: A rising edge causes a logic “0” to be transferred to the communication object. A falling edge does not alter the object value.

“Falling On”: A falling edge causes a logic “1” to be transferred to the communication object. A rising edge does not alter the object value.

“Falling Off”: A falling edge causes a logic “0” to be sent to the communication object. A rising edge does not alter the object value.

“Rising On, Falling Off”: A rising edge causes a logic “1” to be transferred to the communication object. A falling edge causes a logic “0” to be sent.

“Rising Off, Falling On”: A rising edge causes a logic “0” to be transferred to the communication object. A falling edge causes a logic “1” to be sent.

“Toggle ON/OFF”: Each rising edge causes the object value to be inverted. This means that a logic “1” is sent to the communication object after the first rising edge. The next one sends a logic “0” and so on. A falling edge does not alter the object value.

“Toggle OFF/ON”: Each falling edge causes the object value to be inverted. This means that a logic “1” is transferred to the communication object after the first falling edge. The next one sends a logic “0” and so on. A rising edge does not alter the object value.

### **Cyclic Send**

Options:            *ON*  
                          *OFF*

This parameter enables the cyclical sending of current value of Input1 to the bus at a set interval.



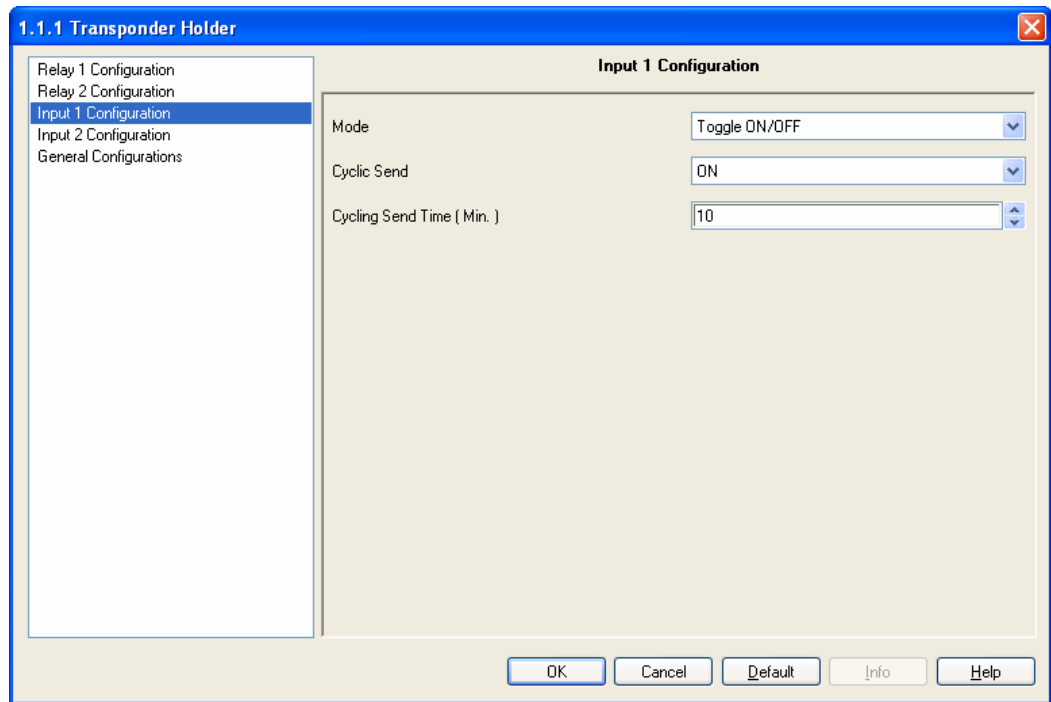

Fig. 6: Parameter Window “Input 1 Configuration” with Cyclic Send enabled (ON).

- **Cycling Send Time (Min)**

Options:      1...10...255

The cyclic time for sending telegrams repeatedly on the bus with Input1 current value is specified here.  
The time units are minutes.

**Note:** please see *Inputs timing diagrams* in “Appication Notes”.

## 5 Communication Objects

The EIB/KNX communication objects provided within the application program “EEL\_HDT1\_10 Transponder Card Holder” are shown next:

Number	Name	Object Function	De...	Length	C	R	W	T	U
0	Door/Courtesy Light	1.001 DPT_Switch		1 bit	C	R	W	T	-
1	Courtesy Light	1.001 DPT_Switch		1 bit	C	R	W	T	-
2	Enable Insert Card	1.003 DPT_Enable		1 bit	C	R	W	T	-
3	Date	11.001 DPT_Date		3 Byte	C	-	W	T	-
4	Time	10.001 DPT_Time		3 Byte	C	-	W	T	-
5	Build Number	7.001 DPT_Value_2_UCount		2 Byte	C	-	W	T	-
6	Guest Data	NO_DPT		10 Byte	C	-	W	T	-
7	Access Code	15.000 DPT_Access_Data		4 Byte	C	-	-	T	-
8	Scenario 1	1.003 DPT_Enable		1 bit	C	R	-	T	-
9	Scenario 2	1.003 DPT_Enable		1 bit	C	R	-	T	-
10	Scenario 3	1.003 DPT_Enable		1 bit	C	R	-	T	-
11	Scenario 4	1.003 DPT_Enable		1 bit	C	R	-	T	-
12	Energy Enabled	1.003 DPT_Enable		1 bit	C	R	-	T	-
13	Room Light Enabled	1.003 DPT_Enable		1 bit	C	R	-	T	-
14	Input 1	1.001 DPT_Switch		1 bit	C	R	-	T	-
15	Input 2	1.001 DPT_Switch		1 bit	C	R	-	T	-
16	Allarm	1.005 DPT_Alarm		1 bit	C	R	-	T	-

Fig. 7: Communication Objects (some objects are visible if enabled by specific parameter setting).

Nr.	Funzione	Nome	Tipo	Flag
0	On/Off	Door/Courtesy Light Relay1	EIS1, 1bit DPT 1.001	C,R,W,T
<p>This object is received from the bus to control the output relay 1 or, in case of “Courtesy Light” setting on relay 2, also the output relay 2.</p> <p>In case the “Door Open” function is enabled this object is named “Door/Courtesy Light” and the relay 1 is switched ON/OFF also in case of valid transponder card reading and consequent entrance acknowledge (for this usage the relay1 should be connected to a door lock).</p> <p>If the Relay 2 has been configured with function “Courtesy Light” this object controls also the Relay 2 (e.g. in case of Hotel application, as this object is received from the bus the transponder holder switch ON the relay 1 opening the door and the relay 2 switching ON the courtesy light).</p> <p>In case of “General Purpose” functional setting this object controls only the relay1 as a normal independent binary output channel.</p> <p>In case the output relay is set as “Normally Open” contact the relay is closed when value “1” is received and it is opened in case of value “0” (vice versa in case of “Normally Closed” contact).</p> <p>If Timing Mode is enabled when an On telegram is received via the Output object (“Relay “1 or “Door/Courtesy Light”), it is routed directly to the relay 1. The Off delay that has been assigned starts at the same time. Every further “1” (ON) that is received before the timer has elapsed, resets the delay and restarts it. Once the period has elapsed, a “0” is passed to the output. An Off telegram deletes the Off delay and is immediately routed to the output.</p>				

Nr.	Funzione	Nome	Tipo	Flag
1	On/Off	Courtesy Light Relay2	EIS1, 1bit DPT 1.001	C,R,W,T
<p>This object is received from the bus to control the output relay 2.</p> <p>In case the "Courtesy Light" function is enabled this object is named "Courtesy Light" and control the relay 2 to be switched ON/OFF. Relay 2 is also switched ON/OFF in case of valid transponder card reading and consequent entrance acknowledge (for this usage the relay2 should be connected to the courtesy light) or also in case the Relay 1 has been configured with function "Door Open".</p> <p>In case of "General Purpose" function associated to Relay 2, this object is named "Relay 2" and controls the output relay 2 as a normal independent binary output channel.</p> <p>In case the output relay is set as "Normally Open" contact the relay is closed when value "1" is received and it is opened in case of value "0" (vice versa in case of "Normally Closed" contact).</p> <p>If Timing Mode is enabled when an On telegram is received via the Output object ("Relay "1" or "Courtesy Light"), it is routed directly to the relay 2. The Off delay that has been assigned starts at the same time. Every further "1" (ON) that is received before the timer has elapsed, resets the delay and restarts it. Once the period has elapsed, a "0" is passed to the output. An Off telegram deletes the Off delay and is immediately routed to the output.</p>				
2	On/Off	Enable Insert Card	EIS1, 1bit DPT 1.003	C,R,W,T
<p>When this object is received (with value "ON") the device simulates a client card reading acknowledge activated the same services:</p> <ul style="list-style-type: none"> <li>➤ Open the door and switch ON the courtesy light</li> <li>➤ Enable energy inside the room (sending the 1 bit object "Energy Enabled")</li> <li>➤ Enable the lighting (sending the 1 bit object "Room Light Enabled")</li> <li>➤ Switch ON "Scenario 1" (scenario associated to "Client" password category).</li> </ul> <p>In case of a card extraction and next insertion the timeout associated to courtesy light and energy activation is reset.</p>				
3	Data	Data	EIS4, 3byte DPT 11.001	C,W,T
<p>The Date object value is used to synchronize the transponder holder with a visualization software and to verify the access qualification of a valid card.</p> <p>In the device and on the card the date is in dd,mm,yy format where "yy" is a number from 90 to 89 and corresponds to the years from 1990 to 2089.</p> <p>The updating is normally done via bus at least one time a day and each time that the supervision centre receives an "Alarm" signal (i.e. after a power failure).</p>				
4	Time	Time	EIS3, 3byte DPT 10.001	C,W,T
<p>The Time object value is used to verify the access qualification of a valid card and to control the timing hour valid range.</p> <p>The updating is done normally via bus at least one time a day and each time that the supervision software (e.g. "eHotel" or "eAccess") receives an "Alarm" signal (i.e. after a power failure).</p>				

<b>Nr.</b>	<b>Funzione</b>	<b>Nome</b>	<b>Tipo</b>	<b>Flag</b>
5	Set Plant ID	Build Number	EIS10, 2byte DPT 7.001	C,W,T
<p>The object "Build Number" is used to identify the installation or the building where the transponder readers and holders are installed.</p> <p>This code avoid any possible risk of using the same card for entrance in two different buildings. It is sent by the building management software during commissioning.</p>				
6	Password	Guest Data	NO DPT 10 byte	C,W,T
<p>The object "Guest Data" is sent by the access control management software to the transponder readers and holders in order to enable entrance and card identification once the transponder card is read.</p> <p>This object (non KNX standard object) contains the user password id, the expiration date, the enabled timing entrance ranges, the valid entrance days of week and the expiration data. After the "Build Number" reading and acceptance the transponder reader or holder controls the password and any other information associated in order to allow or not allow the room entrance.</p> <p><b>"Guest Data" object is normally sent during transponder readers and holders configuration by the access control software ("eAccess" or "eHotel").</b></p>				
7	Access Data	Access Code	EIS12, 4byte DPT 15.000	C,T
<p>This object is used to send to the bus the result of a transponder card reading.</p> <p>Within this object the password and some reading feedbacks are sent to the centralized access control software (e.g. "eHotel" or "eAccess") to be managed or stored.</p>				
8..11	Scenario Enable	Scenario X	EIS1, 1bit DPT 1.003	C,R,T
<p>The card holder identifies each password within 4 users categories and after a card reading acknowledge sends its associated scenario (Scenario 1, 2, ..or 4).</p> <p>For instance, in case of Hotel room management, the four ranges of passwords can be associated to clients, service staff, maintenance staff and emergency service.</p> <p>As the card is extracted from the holder, the device switch OFF the current scenario (so this object is sent to "0" = OFF).</p> <p>The object 8 "Scenario 1" is the only scenario that can be activated also by receiving the "Enable Insert Card" object from the bus (simulation of client room entrance).</p>				



## 6 Application Notes

### Examples of timing diagrams for Inputs

#### 1. Configured with edge evaluation: "rising On"



#### 6. Configured with edge evaluation: "rising Off, falling On"

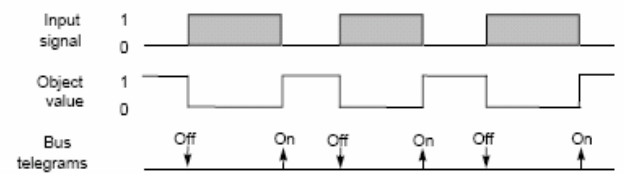

#### 2. Configured with edge evaluation: "rising Off"

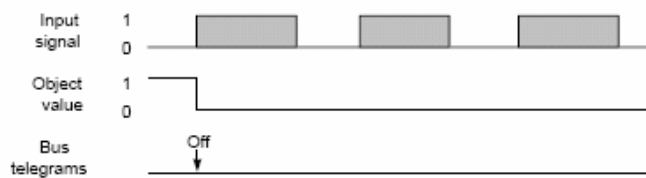

#### 7. Configured with edge evaluation: "Toggle On Off"

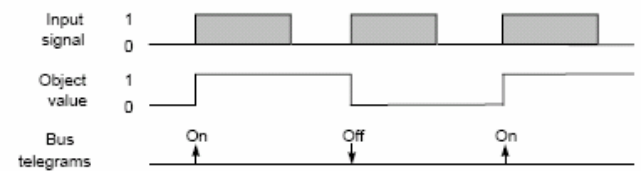

#### 3. Configured with edge evaluation: "falling On"

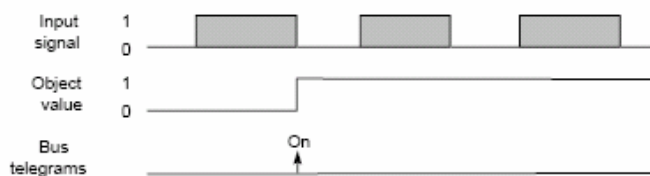

#### 8. Configured with edge evaluation: "Toggle Off/On"

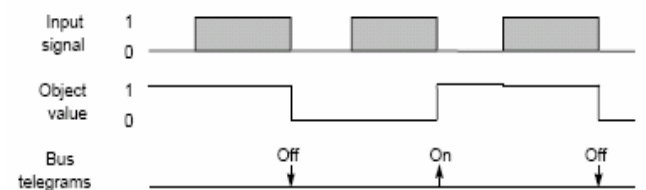

#### 4. Configured with edge evaluation: "falling Off"

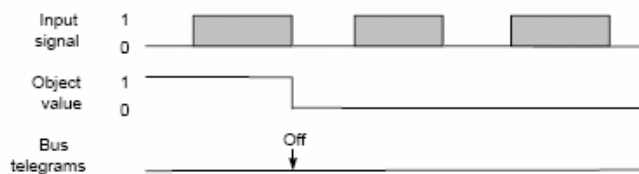

#### 5. Configured with edge evaluation: "rising On, falling Off"

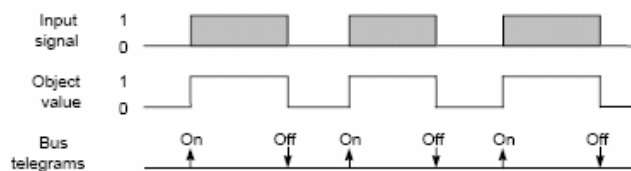

## Examples of timing diagrams for Outputs

### 1. Switching

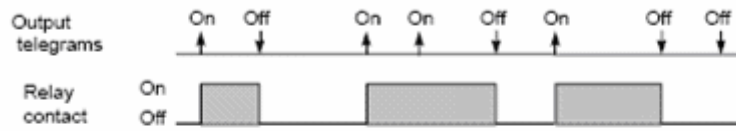

### 2. Switching with a time switch function

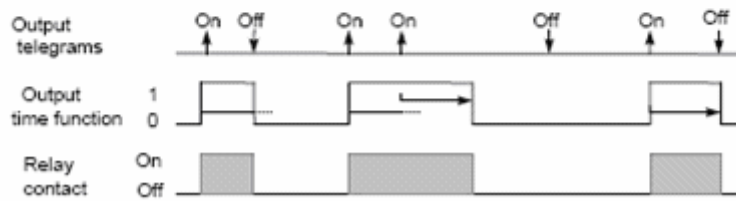

## **LED Signalling**

The Transponder Holder provides only one blue led to enlighten card slot when dark.

This led is enabled with the parameter “Holder Light” in “General Configurations” parameters setting. In case the led usage is disabled the only signalling is concerning a card reading error or card not valid or not acknowledged.

### *Tranponder Holder reading slot LED signalling*

- If parameter “Holder Light” = ON
  - Amber lux fixed ON: card not inside (e.g. device localization when dark)
  - Light flashing for 3 sec.: reading error or card not valid
  - Light OFF: card inside
  
- If parameter “Holder Light” = OFF
  - Light OFF: always (with or without card inside)
  - Light flashing for 3 sec.: reading error or card not valid

- Any information inside this manual can be changed without advice.
- This handbook can be download freely from the website: [www.eelectron.com](http://www.eelectron.com)
- **Exclusion of liability:**  
Despite checking that the contents of this document match the hardware and software, deviations cannot be completely excluded. We therefore cannot accept any liability for this. Any necessary corrections will be incorporated into new versions of the manual.